



Price Guide 2026

Prices valid until Dec 31, 2026

LUMI

Table of Contents

INTRODUCTION 3-5



LIGHT SWING 6-20



SLIDING 21-28



INTERNAL SCREENS 29-31



HEAVY SWING 32-46

ADJUSTABLE 47-49

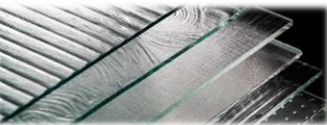

OPTIONS 50-56



WARRANTY, MAINTENANCE & SERVICE 57



LUMI is a bespoke glazing system,
custom designed and tailored specifically to your needs

Your project will be measured, designed, costed, and fabricated to the millimetre, and installed with precision. No two clients are alike, and as such no two designs are the same.

This guide contains price points at a variety of dimensions to best help you estimate costs.



We look forward to working
with you to create elevated
bespoke interiors that speak
to your sensibilities.



KOMANDOR
(905)766-0880
info@komandor.ca



INTRODUCTION – Using this Guide

Systems have been priced out in this guide using:

- the most common measurements to estimate costs
- the black matte finish
- clear laminated safety glass
- clear tempered glass where structurally required
- medium sized D handles on both sides of each door
- no decorative trims (divisions within glass)
- width: minimums and maximums
- height: maximums

Doors swing left or right, up to 170° in preferred direction

Should your project fall outside these parameters, configurations or dimensions please connect with us to find solutions.



Industry Professionals



Trade Pricing 20% off

The Industry Professional placing the order may take this Trade Pricing discount of 20% off the full MSRP of product listed in this Price Guide (delivery and install excluded).

Prices are listed at full MSRP in the guide and do not include taxes.

Charges for freight, crating (if applicable) and brokerage for out of area orders apply, please inquire for a quote

HOW TO USE THE GUIDE - Sample Project

1

FOR ROUGH ESTIMATION ONLY:

Take your own measurements of the opening, or use dimensions from drawings / plans

FOR QUOTES AND ORDERS:

Our rep will take on-site measurements and generate a precise quote while confirming configuration compatibility

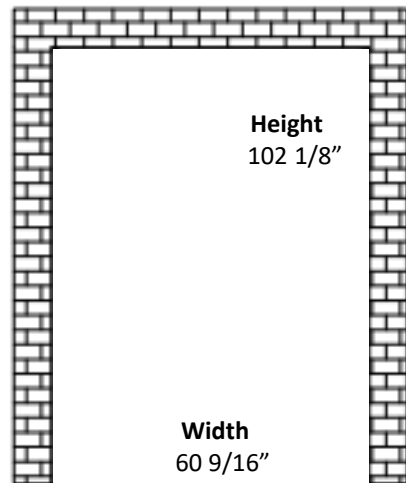

In this sample project, option 6 Double swing doors with fixed transom above has been chosen.

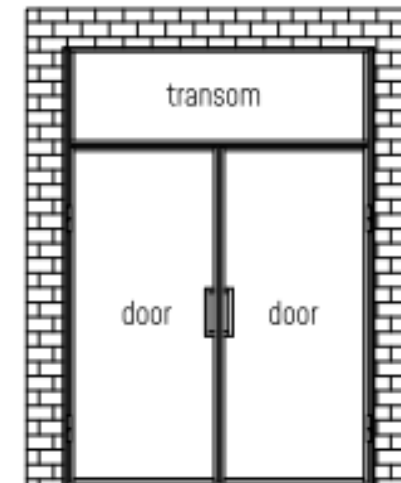

4

Refer to the pricing chart:

Width up to	Price up to 96" Height	Maximum up to 118" Height
42"	\$2,475	\$2,800
46"	\$2,575	\$2,925
50"	\$2,700	\$3,075
54"	\$2,825	\$3,200
58"	\$2,925	\$3,350
62"	\$3,050	\$3,475
66"	\$3,150	\$3,600
70"	\$3,275	\$3,750
74"	\$3,375	\$3,875
78"	\$3,500	\$4,025

Height 103" x Width 61"

5

Now take your rounded measurements, for the purposes of estimated rough costing only, and round up again to the **closest measurements on the chart**. Once you have found the appropriate measurements, your estimated costing is done: \$3,475

However, as you can see, the 103" falls between the 96" Height and the 118" Height. The price will fall somewhere above \$3,050 and below \$3,475

6

For pricing on options such as architectural glass, custom frame finishes, trim, and handle option please refer to pages 47-52 to calculate these customizations.

2

Round your dimensions up to the next inch for pricing and configuration purposes:

3

Decide on the configuration preferred, based on minimum and maximum size allowances compatible with the opening, whether the space can accommodate sliding doors, and the level of privacy desired. In this sample, the following configurations are compatible:

- 4 Single swing door with one fixed panel and fixed transom above
- 6 Double swing doors with fixed transom above
- 8 Single swing door with fixed transom above and two fixed panels
- 14 Single sliding door with a fixed panel
- 15 Double sliding door in a niche
- 24 Privacy Enhanced single swing door with one fixed panel and fixed transom above
- 26 Privacy Enhanced double swing doors with fixed transom above
- 28 Privacy Enhanced single swing door with fixed transom above and two fixed panels

Once you have decided that LUMI is the design solution that meets your needs, please connect with us for a precise quote

LUMI LIGHT SWING DOORS



RECENT RESIDENTIAL SWING DOOR PROJECTS



NOTES

- please be aware that this system has a 5mm gap between the door and the frame on all sides
- double doors have a 5mm gap in the middle
- this system is best installed in an opening with very few imperfections (such as non-level/plumb or uneven edges) in order to avoid unsightly gaps requiring overuse of caulking; please see LUMI Heavy in this case
- accepts D handles or plain Lever handle only
- doors remain in the closed position by engaging with the frame via a pin at the top of the door
- Ideal for partitioning open spaces into separate rooms while retaining light transmission, framing entryway spaces, showcasing walk-in closets

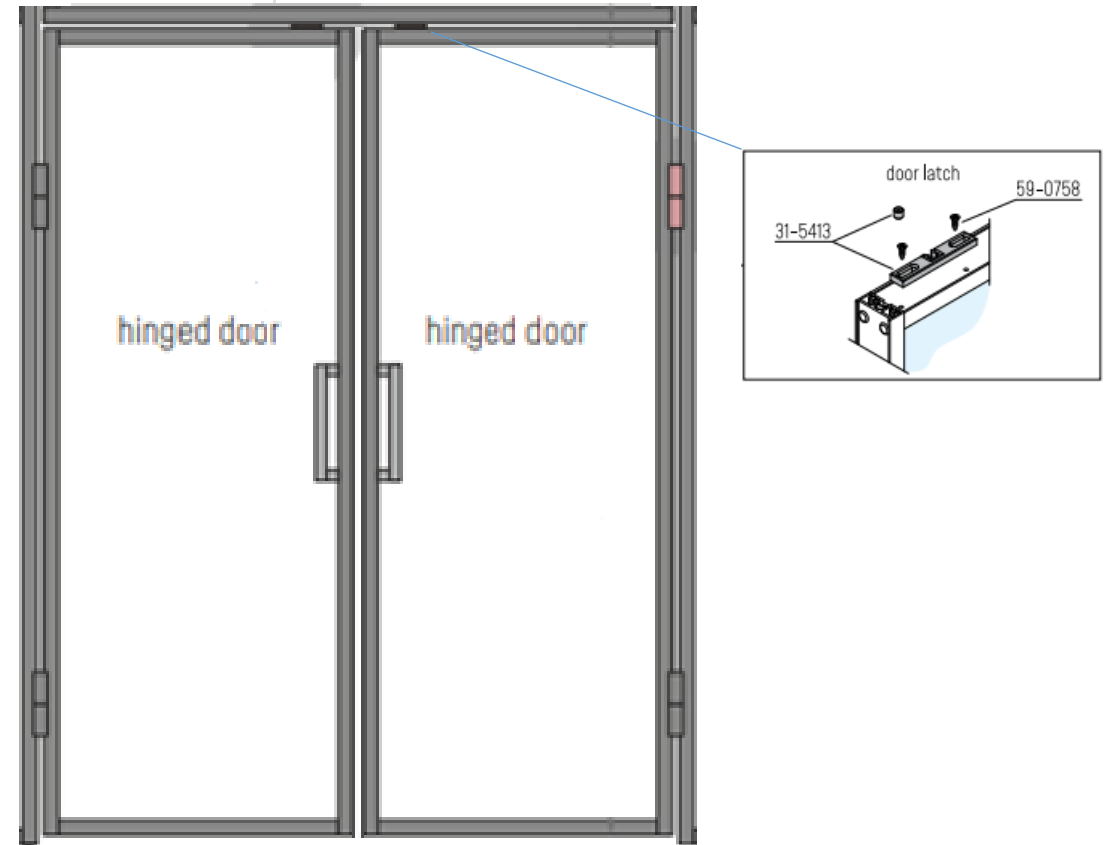

EXCLUSIONS

- not compatible with locking or latching door handles; please see LUMI Heavy in this case
- not compatible with self-closing hinges
- not appropriate for privacy applications such as office spaces, bedrooms or bathrooms; please see LUMI Heavy in this case

LUMI LIGHT - Swing Doors (non-locking/latching partitions)

Single Swing

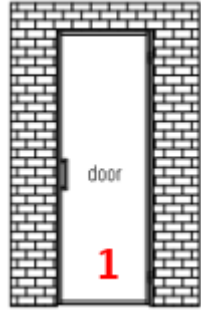

Single Swing , One Fixed

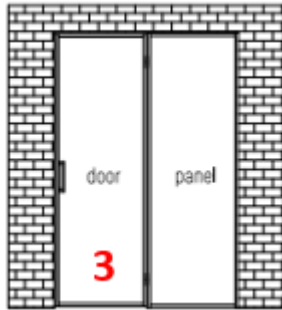

Double Swing



Single Swing , Two Fixed

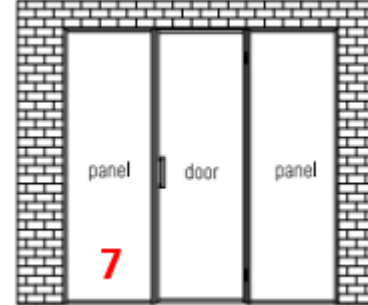

Double Swing , Two Fixed

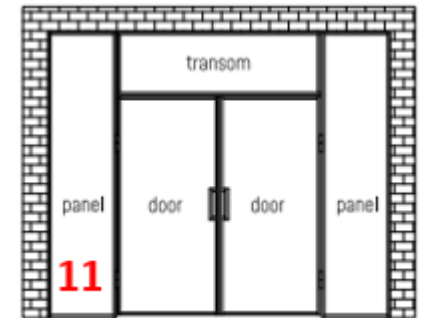
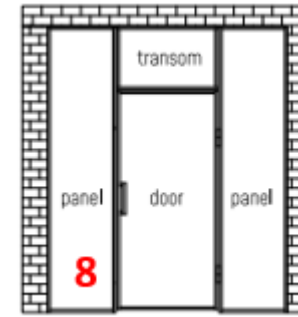
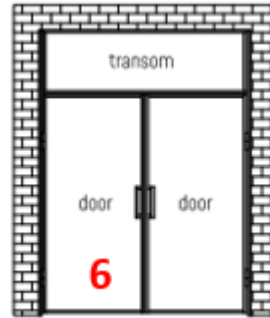
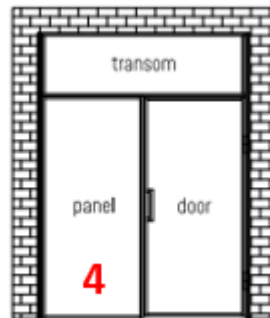
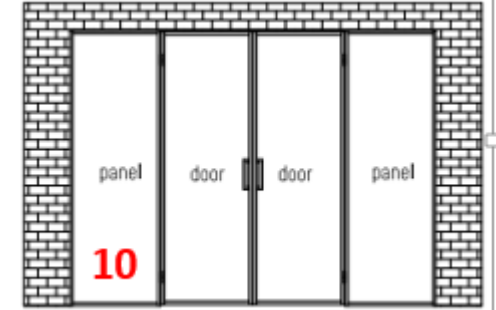

Double Swing, One Fixed

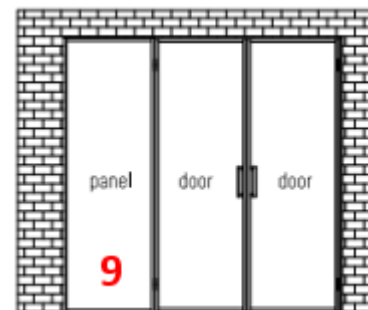

Aluminium construction filled with glass or board, with hinged doors (single or double) in combination with upper transom and side fixed panels, in many configurations. The construction maximum height is 3 m. The length of the entire installation cannot exceed 4 m, and the maximum width of a single fixed panel or hinged doors is 1 m. The maximum height of the transom - 1 m and length - 2 m.

It is possible to make any divisions of the panel filling, horizontally and vertically. In panels higher than 2 m, at least one horizontal division should be made, in order to make the installation rigid. A specially designed vertical handle in three lengths is available for hinged doors. A door handle stylistically matched to the entire structure is on offer as well.



KOMANDOR

LUMI LIGHT - Single swing door

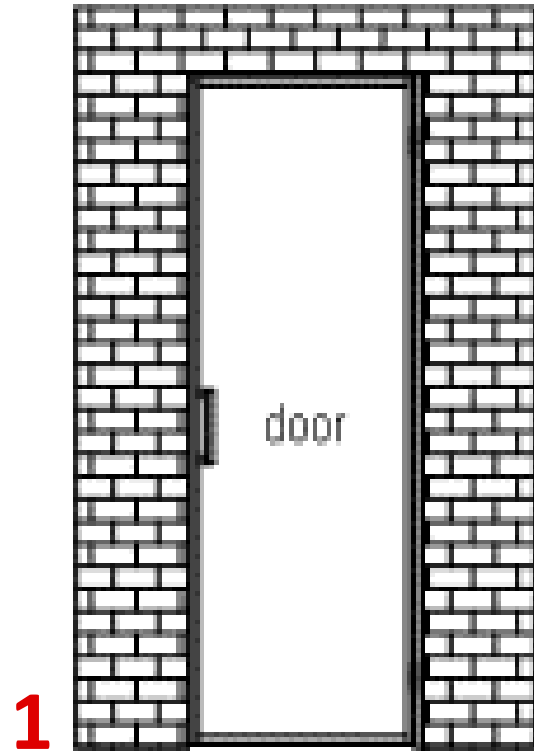

Width up to	Price up to 84" Height	Maximum up to 98" Height
24"	\$1,650	\$1,825
26"	\$1,700	\$1,900
28"	\$1,750	\$1,950
30"	\$1,825	\$2,025
32"	\$1,875	\$2,100
34"	\$1,925	\$2,175
36"	\$2,000	\$2,225
38"	\$2,050	\$2,300
39"	\$2,075	\$2,325

Ideas

- trim is additional and handle costs vary



- Fee for delivery and installation in the GTA: **\$182**

LUMI LIGHT - Single swing door with fixed transom above

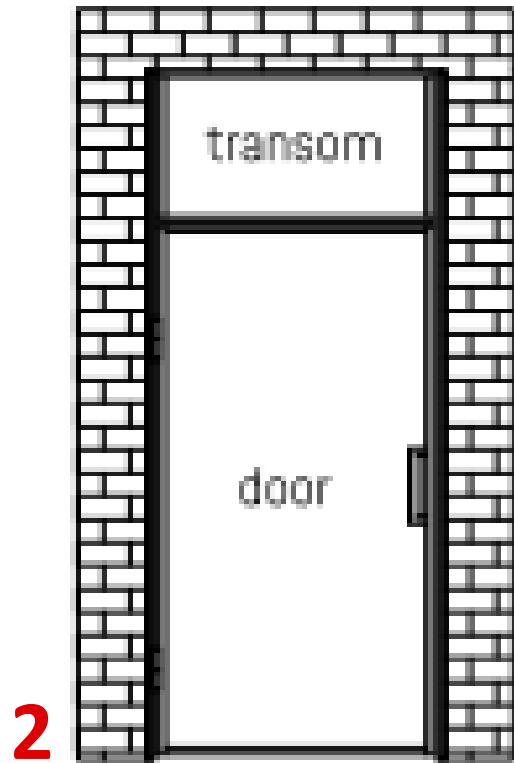

Width up to	Price up to 96" Height	Maximum up to 118" Height
24"	\$2,275	\$2,575
26"	\$2,350	\$2,675
28"	\$2,450	\$2,775
30"	\$2,525	\$2,875
32"	\$2,600	\$2,975
34"	\$2,700	\$3,075
36"	\$2,775	\$3,175
38"	\$2,875	\$3,275
39"	\$2,925	\$3,325

Ideas

- trim is additional and handle costs vary



- Door and transom height proportion per customer specification
- Fee for delivery and installation in the GTA: **\$410**

LUMI LIGHT - Single swing door with one fixed panel

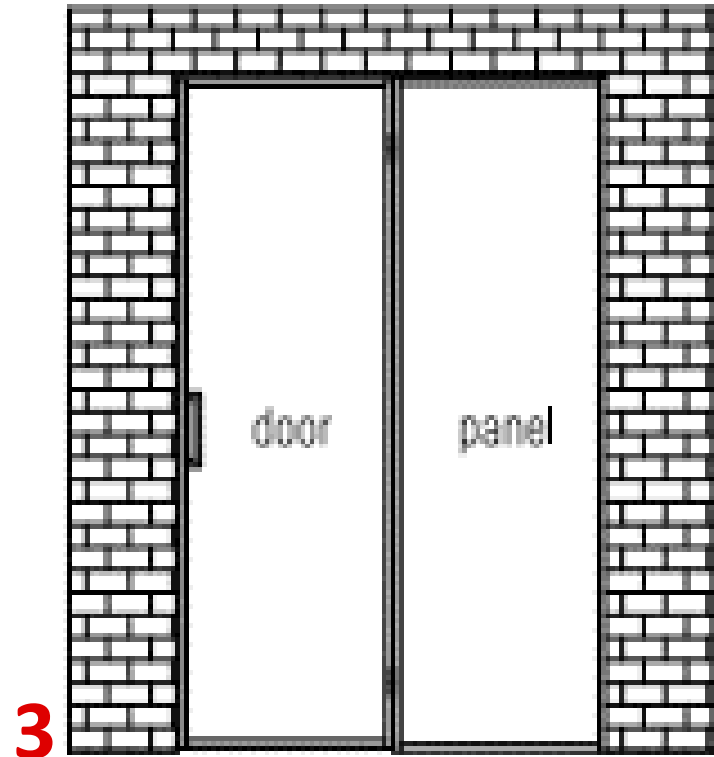

Width up to	Price up to 84" Height	Maximum up to 98" Height
42"	\$3,000	\$3,325
46"	\$3,150	\$3,475
50"	\$3,300	\$3,650
54"	\$3,450	\$3,800
58"	\$3,575	\$3,975
62"	\$3,725	\$4,125
66"	\$3,875	\$4,300
70"	\$4,025	\$4,475
74"	\$4,175	\$4,625
78"	\$4,325	\$4,800

Ideas

- trim is additional and handle costs vary

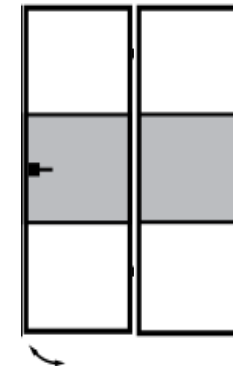

- Fee for delivery and installation in the GTA: **\$318**

LUMI LIGHT - Single swing door with one fixed panel and fixed transom above

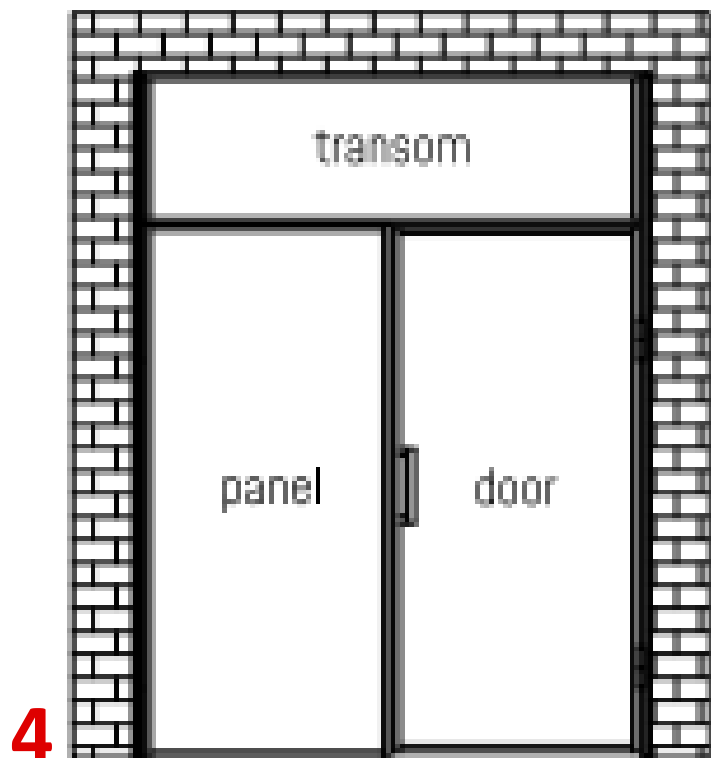

Width up to	Price up to 96" Height	Maximum up to 118" Height
42"	\$3,675	\$4,225
46"	\$3,850	\$4,425
50"	\$4,025	\$4,625
54"	\$4,200	\$4,825
58"	\$4,375	\$5,050
62"	\$4,550	\$5,250
66"	\$4,725	\$5,450
70"	\$4,900	\$5,650
74"	\$5,100	\$5,875
78"	\$5,275	\$6,075

Ideas

- trim is additional and handle costs vary

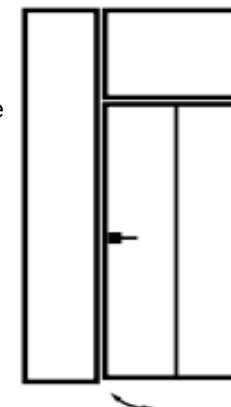

- Door and transom height proportion per customer specification
- Fee for delivery and installation in the GTA: **\$545**

LUMI LIGHT - Double swing doors

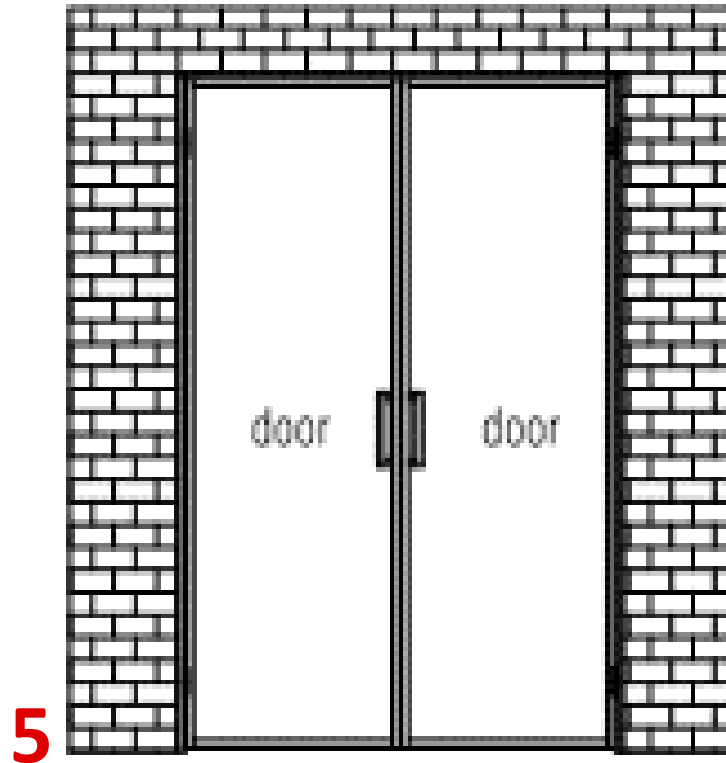

Width up to	Price up to 84" Height	Maximum up to 98" Height
42"	\$2,850	\$3,150
46"	\$2,975	\$3,300
50"	\$3,100	\$3,425
54"	\$3,200	\$3,575
58"	\$3,325	\$3,700
62"	\$3,450	\$3,850
66"	\$3,575	\$3,975
70"	\$3,675	\$4,125
74"	\$3,800	\$4,250
78"	\$3,925	\$4,375

Ideas

- trim is additional and handle costs vary

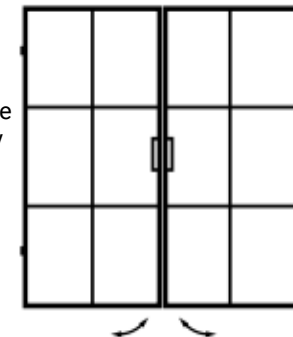

- Fee for delivery and installation in the GTA: **\$273**

LUMI LIGHT - Double swing doors with fixed transom above

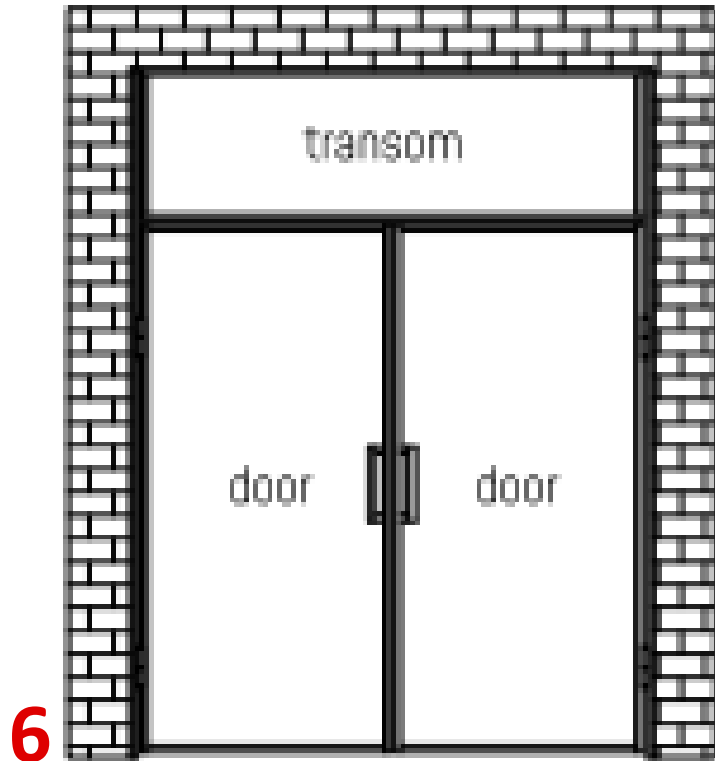

Width up to	Price up to 96" Height	Maximum up to 118" Height
42"	\$3,650	\$4,250
46"	\$3,825	\$4,450
50"	\$4,000	\$4,650
54"	\$4,175	\$4,875
58"	\$4,350	\$5,075
62"	\$4,525	\$5,275
66"	\$4,725	\$5,475
70"	\$4,900	\$5,675
74"	\$5,075	\$5,875
78"	\$5,250	\$6,100

Ideas

- trim is additional and handle costs vary



- Door and transom height proportion per customer specification
- Fee for delivery and installation in the GTA: **\$410**

LUMI LIGHT - Single swing door with two fixed panels

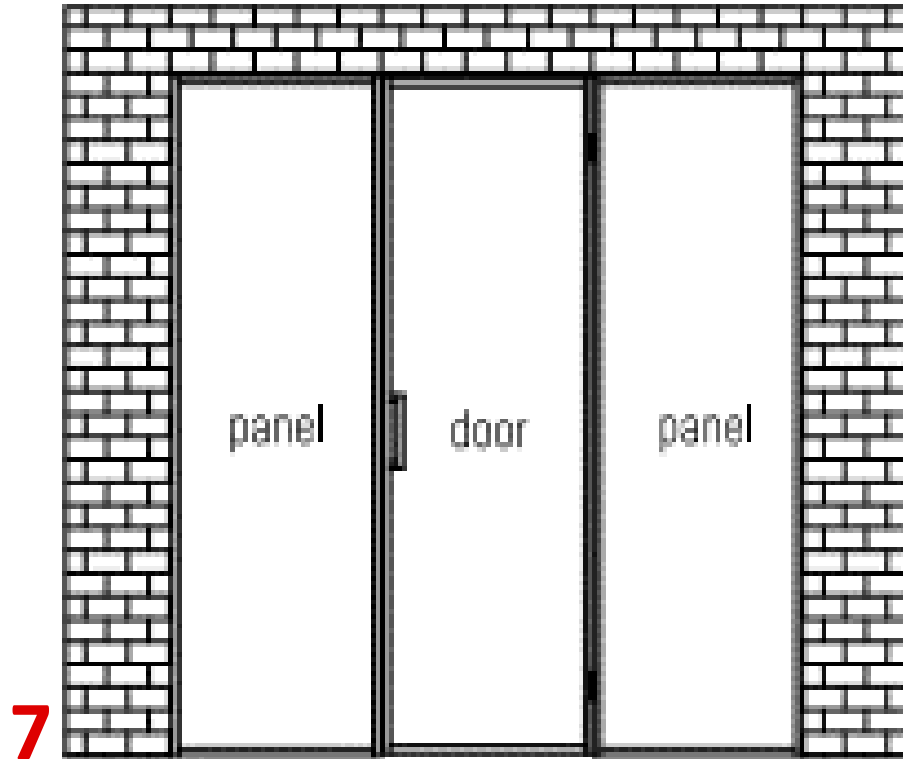

Width up to	Price up to 84" Height	Maximum up to 98" Height
48"	\$3,825	\$4,250
56"	\$4,125	\$4,575
64"	\$4,425	\$4,900
72"	\$4,700	\$5,225
80"	\$5,000	\$5,550
88"	\$5,300	\$5,900
96"	\$5,600	\$6,225
104"	\$5,875	\$6,550
112"	\$6,175	\$6,875
118"	\$6,400	\$7,125

Ideas

- trim is additional and handle costs vary

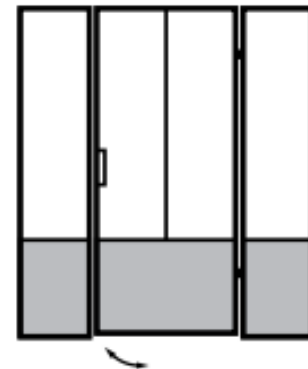

- Fee for delivery and installation in the GTA: **\$455**

LUMI LIGHT - Single swing door with fixed transom above and two fixed panels

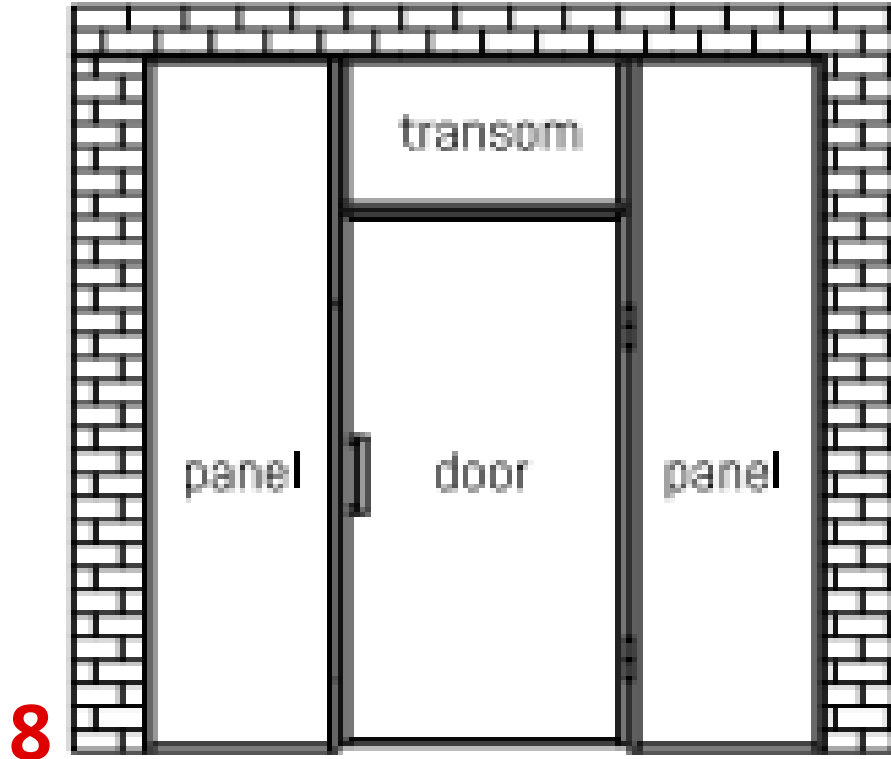

Width up to	Price up to 96" Height	Maximum up to 118" Height
46"	\$4,525	n/a
54"	\$4,875	n/a
62"	\$5,200	n/a
70"	\$5,475	n/a
78"	\$5,825	n/a
86"	\$6,150	\$7,200
94"	\$6,475	\$7,625
102"	\$6,800	\$8,025
110"	\$7,150	\$8,425
118"	\$7,475	\$8,825

Ideas

- trim is additional and handle costs vary

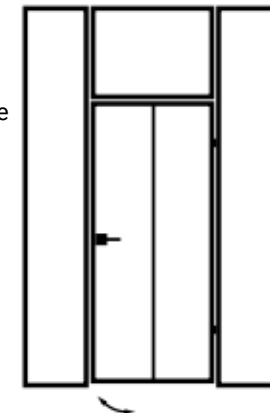

- Door and transom height proportion per customer specification
- Fee for delivery and installation in the GTA: **\$682**

LUMI LIGHT - Double swing doors with one fixed panel

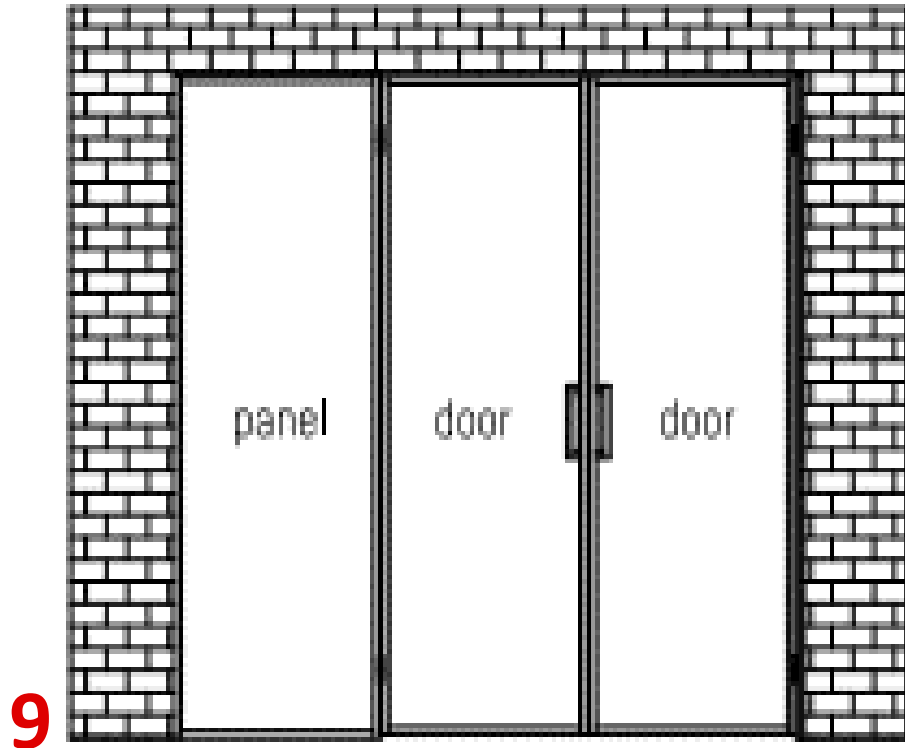

Width up to	Price up to 84" Height	Maximum up to 98" Height
48"	\$3,825	\$4,250
54"	\$4,025	\$4,500
62"	\$4,300	\$4,825
70"	\$4,575	\$5,150
78"	\$4,825	\$5,475
86"	\$5,100	\$5,800
94"	\$5,375	\$6,125
102"	\$5,650	\$6,450
110"	\$5,900	\$6,775
118"	\$6,175	\$7,125

Ideas

- trim is additional and handle costs vary

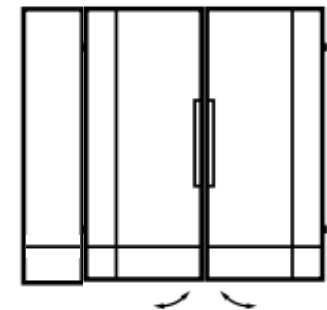

- Fee for delivery and installation in the GTA: **\$454**

LUMI LIGHT - Double swing doors with two fixed panels

10

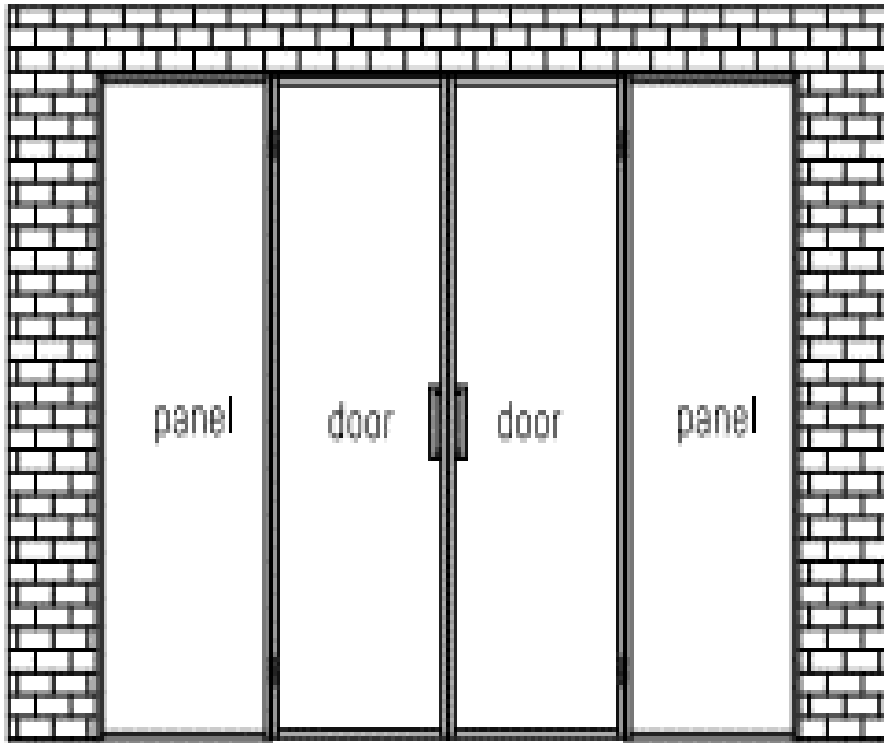

Width up to	Price up to 84" Height	Maximum up to 98" Height
60"	\$4,975	\$5,475
70"	\$5,325	\$5,875
80"	\$5,675	\$6,275
90"	\$6,025	\$6,650
100"	\$6,375	\$7,050
110"	\$6,725	\$7,450
120"	\$7,100	\$7,850
130"	\$7,450	\$8,250
140"	\$7,800	\$8,625
156"	\$8,375	\$9,275

Ideas

- trim is additional and handle costs vary

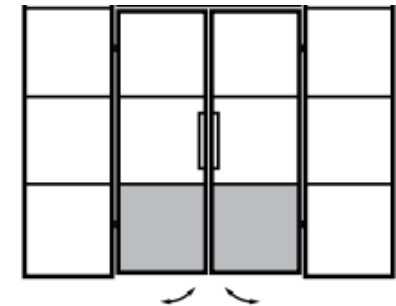

- Fee for delivery and installation in the GTA: **\$545**

LUMI LIGHT - Double swing doors with fixed transom above and two fixed panels

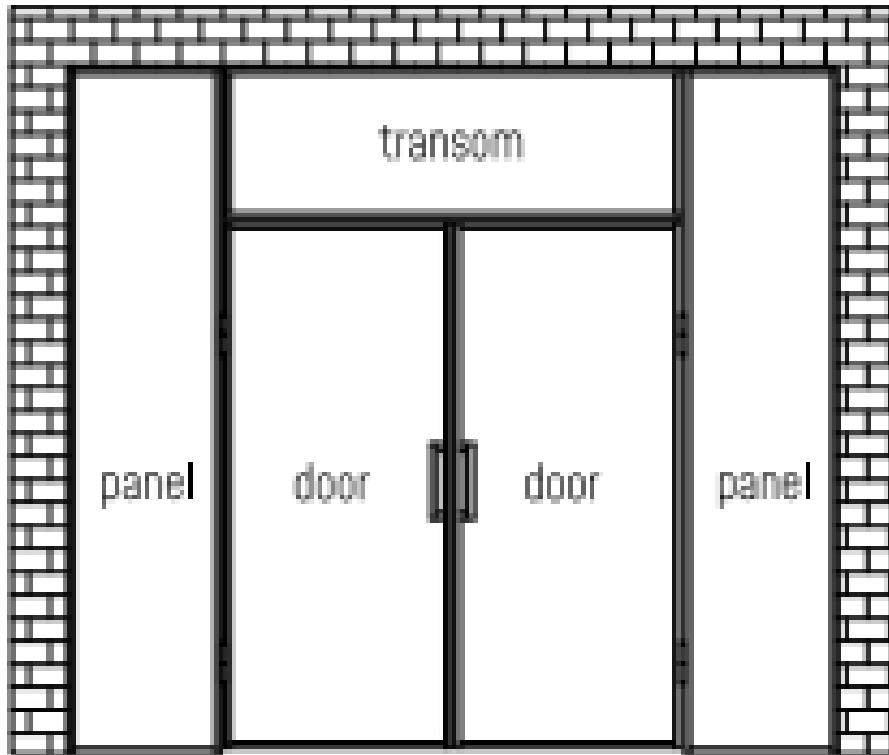

11

Width up to	Price up to 96" Height	Maximum up to 118" Height
60"	\$5,725	n/a
70"	\$6,125	n/a
80"	\$6,525	\$7,525
90"	\$6,950	\$8,025
100"	\$7,400	\$8,550
110"	\$7,825	\$9,050
120"	\$8,250	\$9,550
130"	\$8,675	\$10,075
140"	\$9,100	\$10,575
156"	\$9,775	\$11,375

Ideas

- trim is additional and handle costs vary

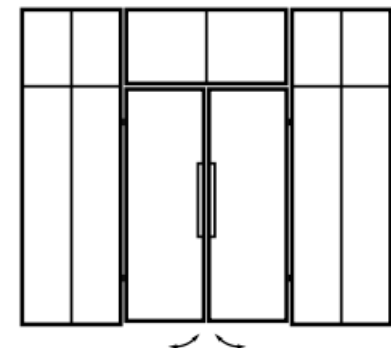

- Door and transom height proportion per customer specification
- Fee for delivery and installation in the GTA: **\$773**

LUMI SLIDING DOORS



RECENT RESIDENTIAL SLIDING DOOR PROJECTS



LUMI SLIDING

Single Sliding Door Next to a Wall

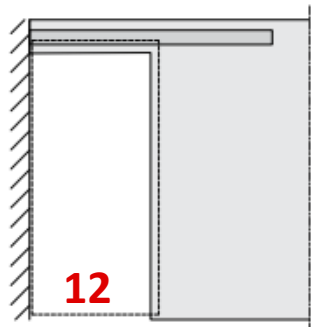

12

door wall



Single Sliding Door In a Niche

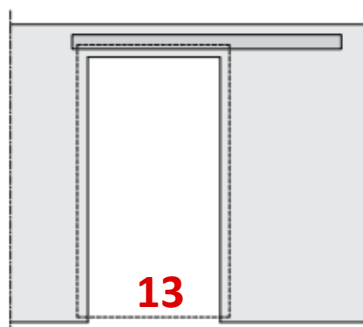

13

wall door wall



Single Sliding Door With a Fixed Panel

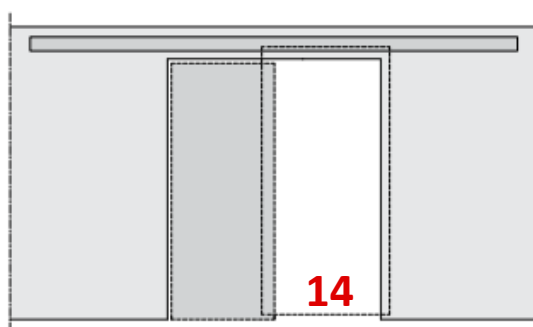

14

fixed panel door



KOMANDOR

Double Sliding Door In a Niche

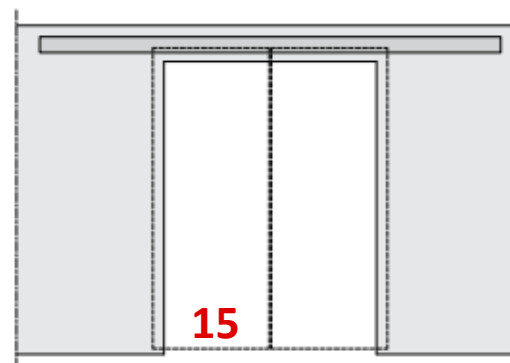

15

wall door door wall



Double Sliding Door With Two Fixed Panel

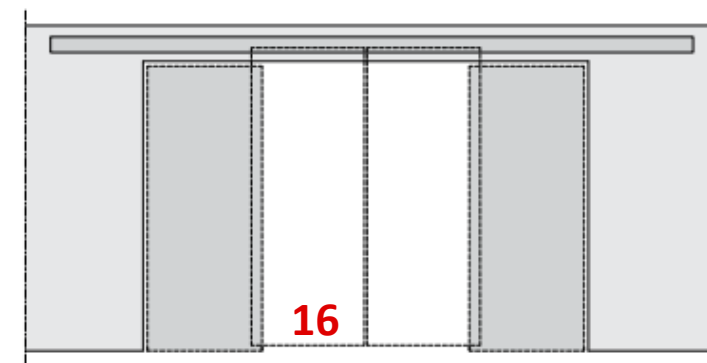

16

fixed panel door door fixed panel

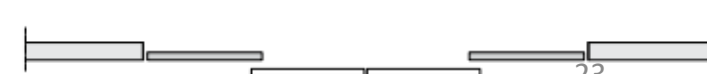

Single or double aluminium sliding doors, filled with glass or board, in combination with fixed side panels in various configurations, give the room an industrial feel.

The maximum height of the installation is 3 m and the length is 5 m. The width cannot exceed 1 m for fixed panel and 1,5 m for sliding door. Horizontal and vertical divisions can be made in any arrangement for both.

A special handle available in three lengths has been designed for the doors. Construction components are available in two colours: black matt and natural anode.

LUMI SLIDING - Single sliding door next to a wall

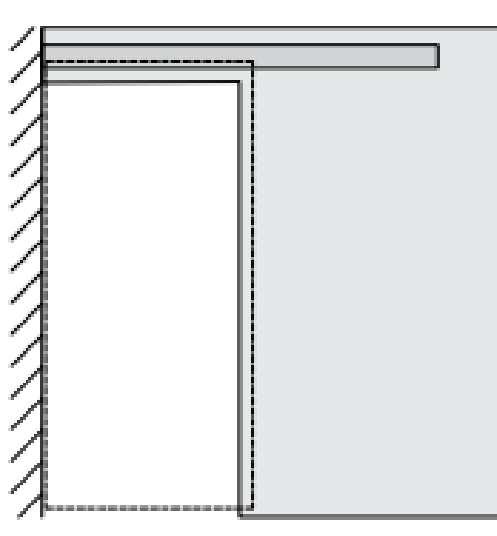

Opening Width up to	Price up to 84" Height	Price up to 96" Height	Maximum up to 118" Height
30"	\$2,050	\$2,200	\$2,525
36"	\$2,300	\$2,475	\$2,850
42"	\$2,550	\$2,900	\$3,175
48"	\$2,875	\$3,100	\$3,500
54"	\$3,100	\$3,350	\$3,800
57"	\$3,200	\$3,475	\$3,950

12

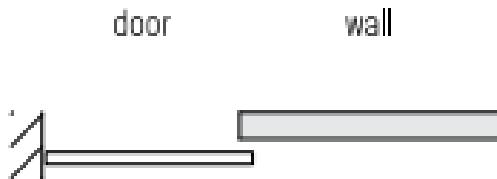

Ideas

- trim is additional and handle costs vary

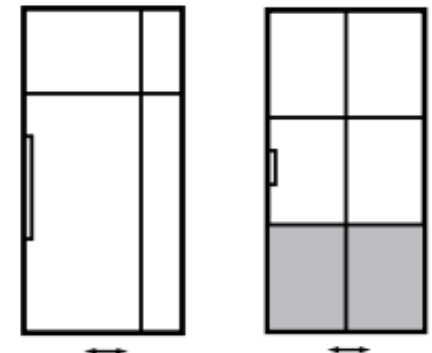

- Fee for delivery and installation in the GTA: **\$278**

LUMI SLIDING - Single sliding door in a niche

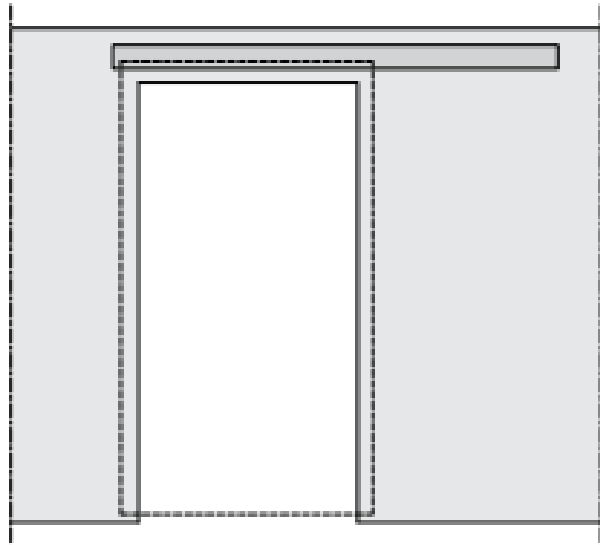

wall door wall

13



Opening Width up to	Price up to 84" Height	Price up to 96" Height	Maximum up to 118" Height
30"	\$2,050	\$2,200	\$2,525
36"	\$2,300	\$2,475	\$2,850
42"	\$2,550	\$2,900	\$3,175
48"	\$2,875	\$3,100	\$3,500
54"	\$3,100	\$3,350	\$3,800
57"	\$3,200	\$3,475	\$3,950



Ideas

- o trim is additional and handle costs vary

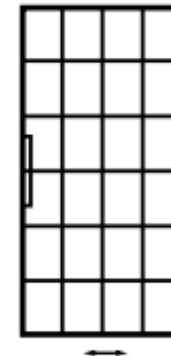

- Fee for delivery and installation in the GTA: **\$278**

LUMI SLIDING - Single sliding door with a fixed panel

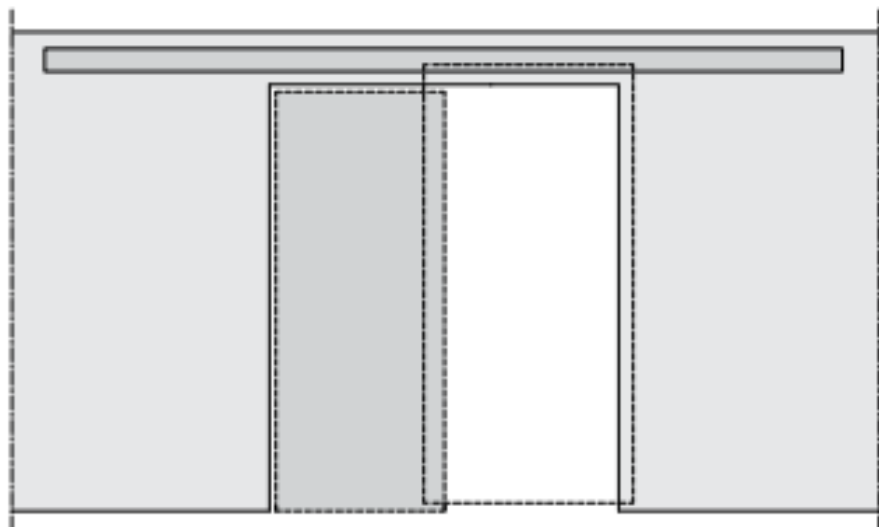

fixed panel door

14



Opening Width up to	Price up to 84" Height	Price up to 96" Height	Maximum up to 118" Height
34"	\$2,900	\$3,150	\$3,575
48"	\$3,050	\$3,325	\$3,800
60"	\$3,525	\$3,850	\$4,425
72"	\$3,950	\$4,325	\$4,900
84"	\$4,400	\$4,825	\$5,500
96"	\$4,850	\$5,325	\$6,175

Ideas

- o trim is additional and handle costs vary

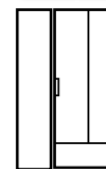

- Fee for delivery and installation in the GTA: **\$415**

LUMI SLIDING - Double sliding door in a niche

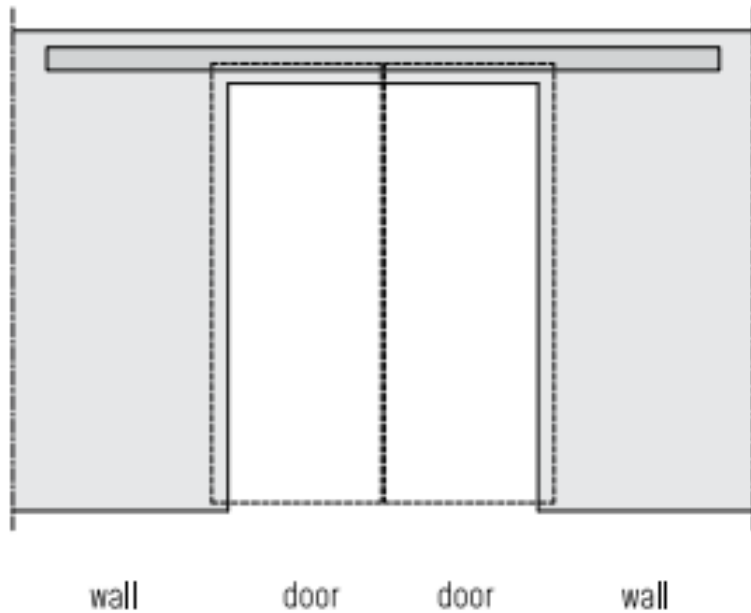

15



Opening Width up to	Price up to 84" Height	Price up to 96" Height	Maximum up to 118" Height
48"	\$3,525	\$3,775	\$4,300
60"	\$4,050	\$4,350	\$5,000
72"	\$4,575	\$4,900	\$5,650
84"	\$5,125	\$5,500	\$6,375
96"	\$5,575	\$6,000	\$6,975
108"	\$5,950	\$6,400	\$7,525
116"	\$6,175	\$6,650	\$7,850

Ideas

- trim is additional and handle costs vary

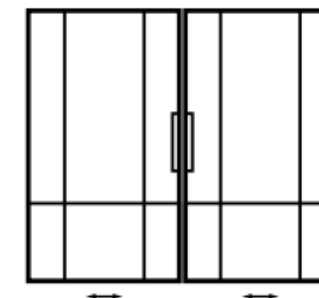

- Fee for delivery and installation in the GTA: **\$278**

LUMI SLIDING - Double sliding door in a niche with two fixed panels

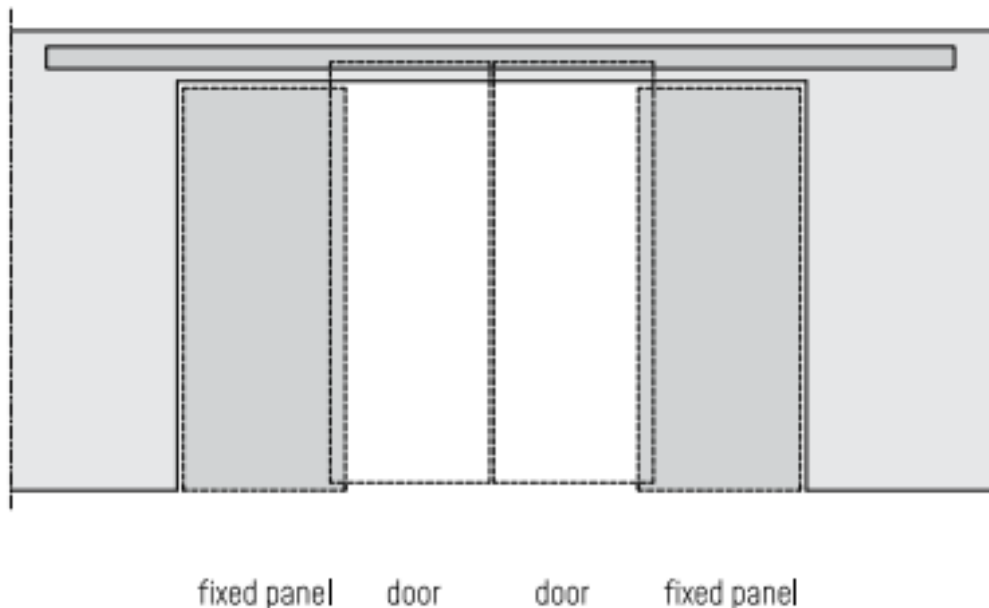

Opening Width up to	Price up to 84" Height	Price up to 96" Height	Maximum up to 118" Height
68"	\$4,400	\$4,825	\$5,675
72"	\$4,550	\$4,975	\$5,875
88"	\$5,150	\$5,650	\$6,675
104"	\$5,750	\$6,375	\$7,500
120"	\$6,375	\$7,000	\$8,325
136"	\$6,975	\$7,675	\$9,200
152"	\$7,600	\$8,350	\$9,975
168"	\$8,225	\$9,050	\$10,800
184"	\$8,850	\$9,750	\$11,650
195"	\$9,325	\$10,275	\$12,250

16



Ideas

- trim is additional and handle costs vary
- single sliding door with two fixed panels

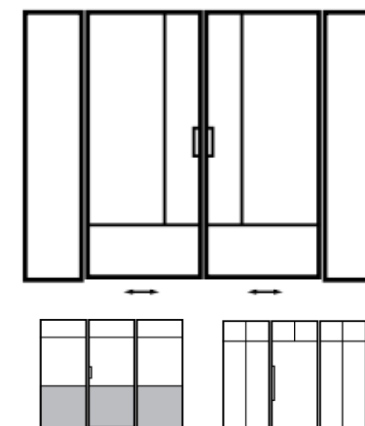

- Fee for delivery and installation in the GTA: **\$461**

LUMI

INTERNAL SCREENS



LUMI INTERNAL SCREENS

Open Screen

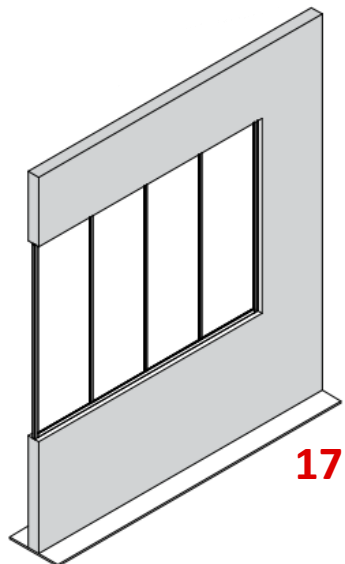

Cross Screen

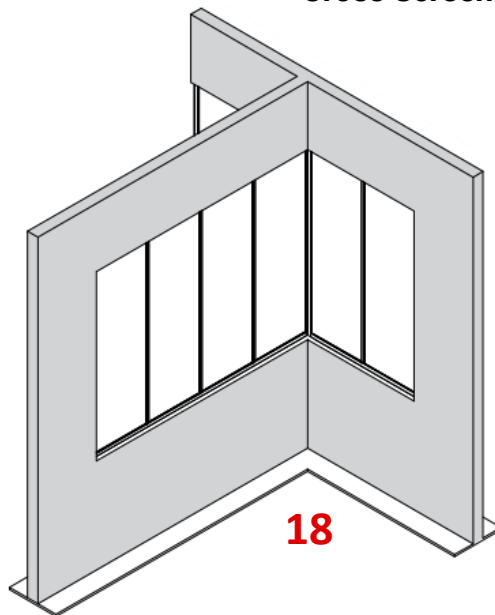

Floor to Ceiling

- maximum height of 118"
- unlimited width provided it is attached to one wall
- max width per panel 39"

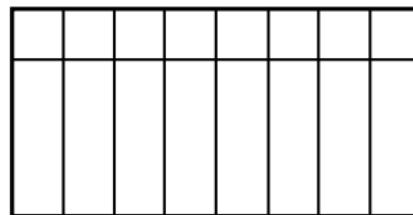

KOMANDOR

Glazed internal screens with mullions, functioning as subtle partition walls. They provide additional light, soundproofing and optically enlarge the interior, giving the space separate functions. They stand out with their simple, minimalist form and lightness.

The screens are build of fixed panels only, based on subtle aluminium profiles in a black matt or natural anode finishing. The screens maximum height is 2 m, and the width is 2.75 m. Unlimited vertical and horizontal divisions of the screens and the multitude of design options provide wide possibilities of arranging the interior.

Corner Screen

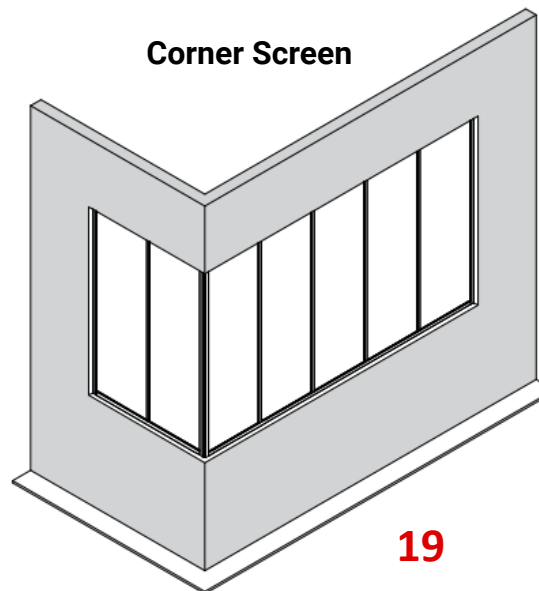

Closed Screen

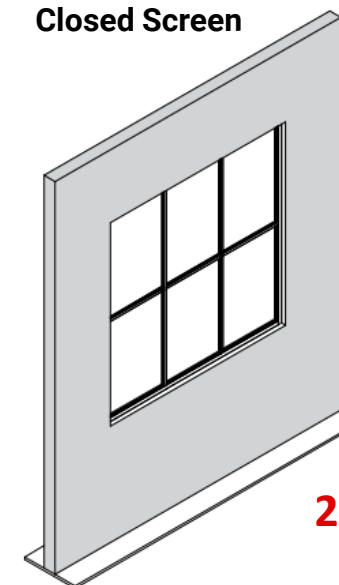

LUMI INTERNAL SCREENS

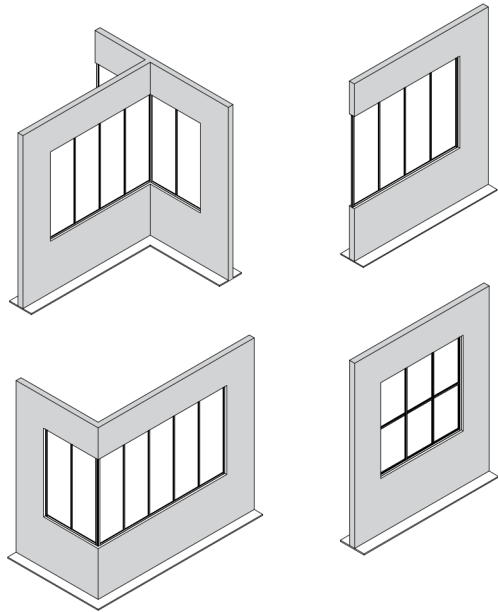

Opening Width up to	Price up to 36" Height	Price up to 48" Height	Price up to 60" Height	Maximum up to 78" Height
36"	\$700	\$900	\$1,100	\$1,350
48"	\$900	\$1,150	\$1,400	\$1,725
60"	\$1,100	\$1,400	\$1,700	\$2,100
72"	\$1,250	\$1,600	\$1,950	\$2,425
84"	\$1,525	\$1,925	\$2,325	\$2,850
108"	\$1,825	\$2,325	\$2,825	\$3,525

- On heights below 36" (to a minimum of 10") please connect with us for a quote
- May be installed floor to ceiling, to a maximum height of 118" and unlimited width in panels up to 39" each

17-20 Trim (as shown in images above) **NOT** included in price



Ideas

- trim is additional

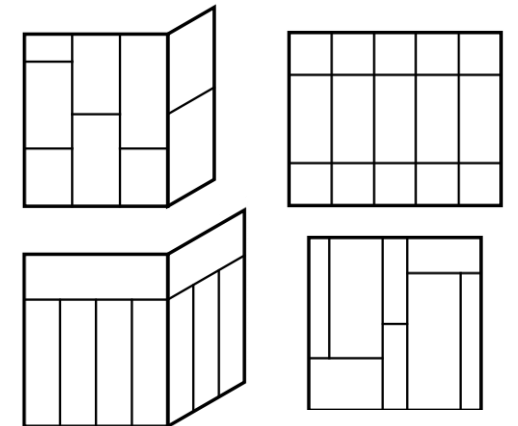

- Fee for delivery and installation in the GTA: **\$136**

LUMI HEAVY



RECENT COMMERCIAL PROJECTS



NOTES

SINGLE DOORS:

- No gaps between door frame and door jamb
- Door jamb features integrated door stop
- Highly adjustable for openings with imperfection
- Compatible with self-closing hinges
- Ideal for privacy applications such as offices, bedrooms and bathroom entrances

DOUBLE DOORS:

- 5mm gap where doors meet in the middle, no gaps between door frame and door jamb
- Door jamb features integrated door stop
- Highly adjustable for openings with imperfection
- Compatible with self-closing hinges
- Locking double doors have a slider at the top and bottom of one door

EXCLUSIONS

- not compatible with deadbolts

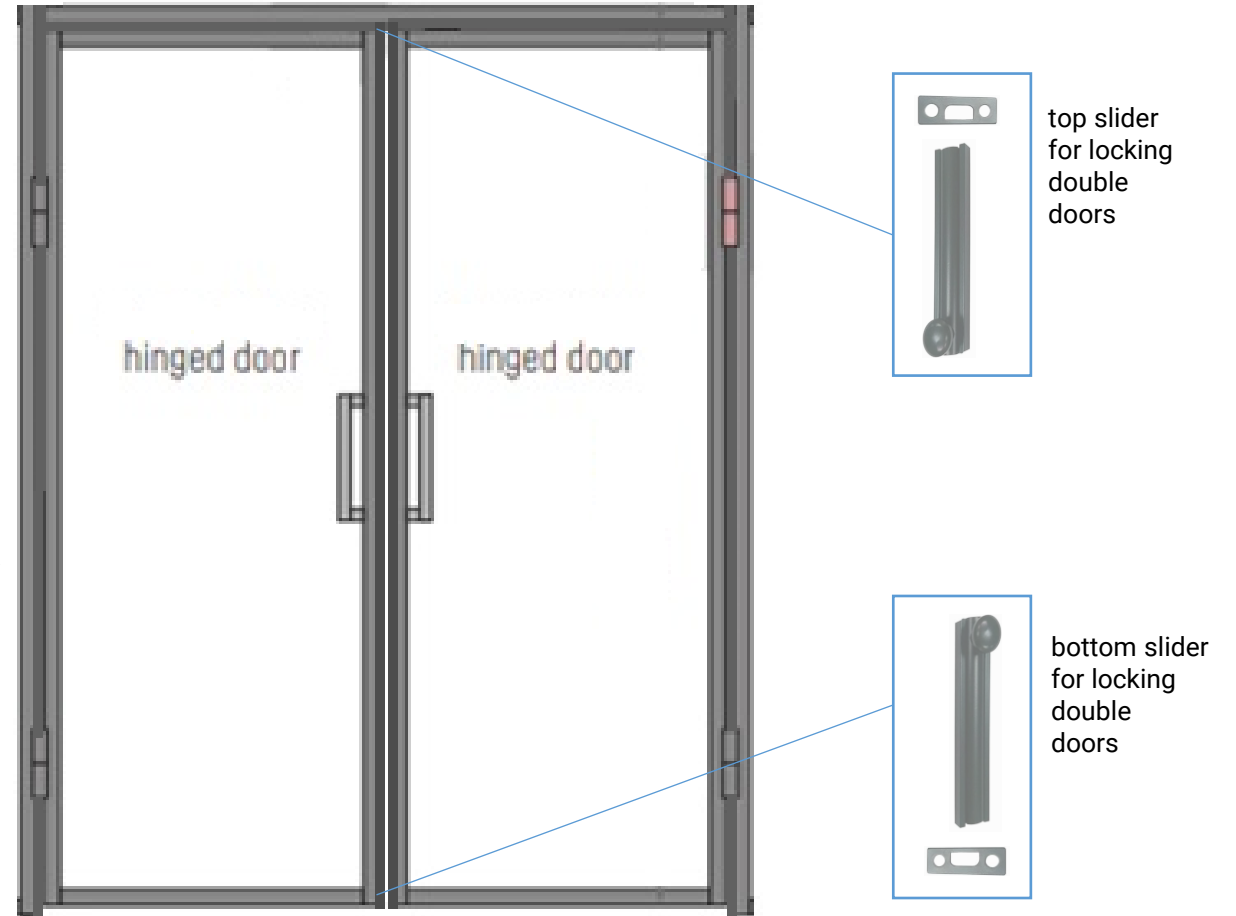

LUMI HEAVY - Privacy Enhanced Swing Doors (locking/latching partitions)

Single Swing

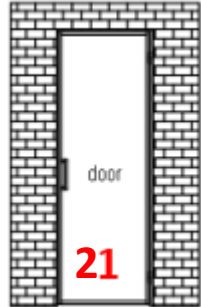

Single Swing , One Fixed

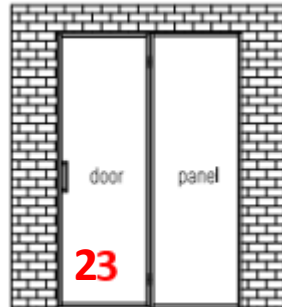

Double Swing



Single Swing , Two Fixed

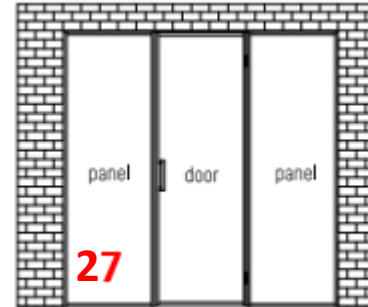

Double Swing , Two Fixed

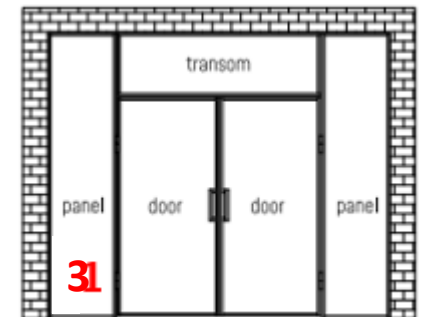
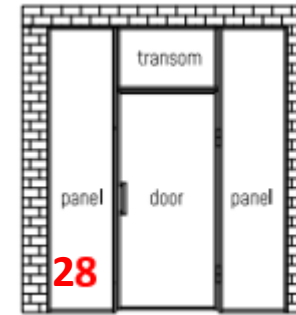
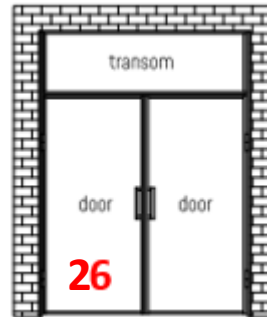
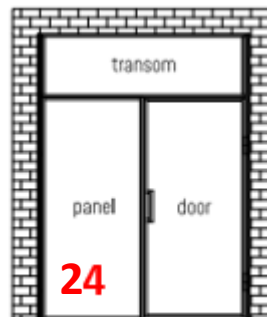
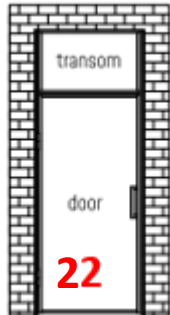
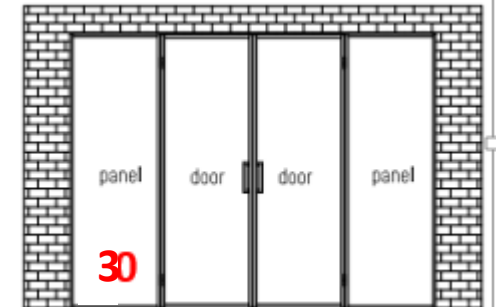

Double Swing, One Fixed

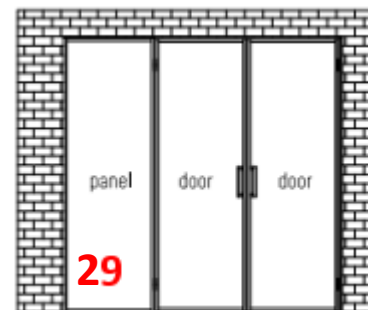

Aluminium construction filled with glass or board, with hinged doors (single or double) in combination with upper transom and side fixed panels, in many configurations. The construction maximum height is 3 m. The length of the entire installation cannot exceed 4 m, and the maximum width of a single fixed panel or hinged doors is 1 m. The maximum height of the transom - 1 m and length - 2 m.

It is possible to make any divisions of the panel filling, horizontally and vertically. In panels higher than 2 m, at least one horizontal division should be made, in order to make the installation rigid. A specially designed vertical handle in three lengths is available for hinged doors. A door handle stylistically matched to the entire structure is on offer as well.



KOMANDOR

LUMI HEAVY - Privacy Enhanced single swing door

21

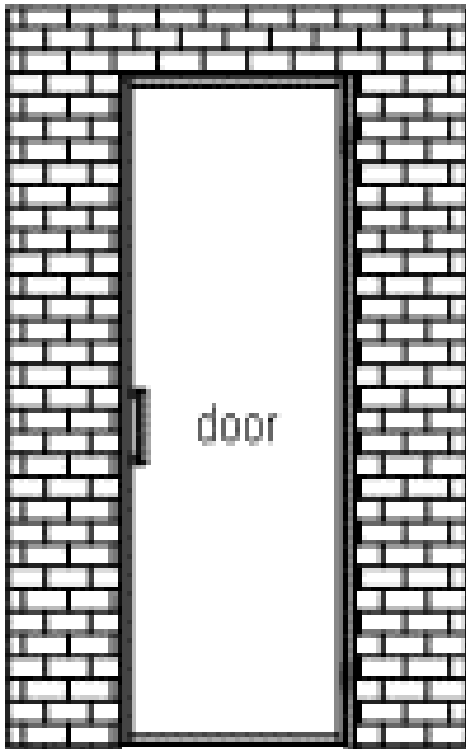

Width up to	Price up to 84" Height	Maximum up to 98" Height
24"	n/a	n/a
26"	\$2,200	\$2,525
28"	\$2,275	\$2,600
30"	\$2,325	\$2,675
32"	\$2,400	\$2,750
34"	\$2,475	\$2,825
36"	\$2,525	\$2,900
38"	\$2,600	\$2,975
40"	\$2,675	\$3,050

Ideas

- trim is additional and handle costs vary



- Fee for delivery and installation in the GTA: **\$250**

LUMI HEAVY - Privacy Enhanced single swing door with fixed transom above

22

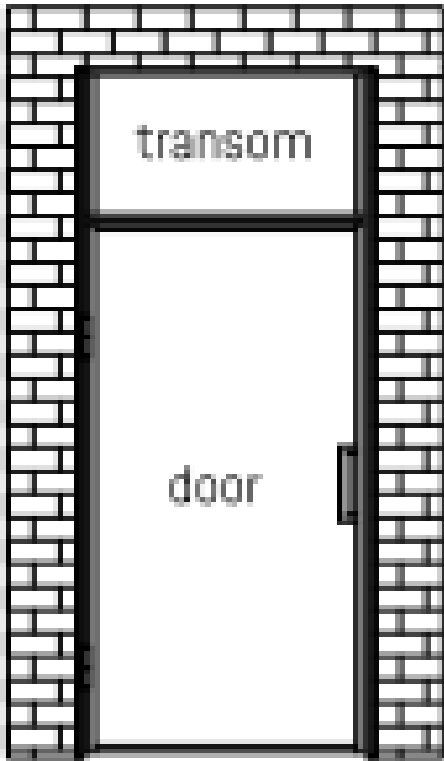

Width up to	Price up to 96" Height	Maximum up to 118" Height
24"	\$0	\$0
26"	\$2,525	\$2,975
28"	\$2,600	\$3,050
30"	\$2,650	\$3,125
32"	\$2,725	\$3,200
34"	\$2,800	\$3,300
36"	\$2,875	\$3,375
38"	\$2,925	\$3,450
40"	\$3,000	\$3,500

Ideas

- trim is additional and handle costs vary

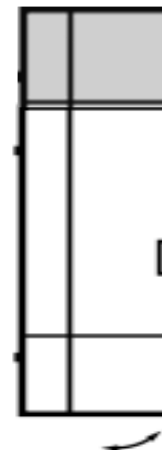

- Door and transom height proportion per customer specification
- Fee for delivery and installation in the GTA: **\$342**

LUMI HEAVY - Privacy Enhanced single swing door with one fixed panel

23

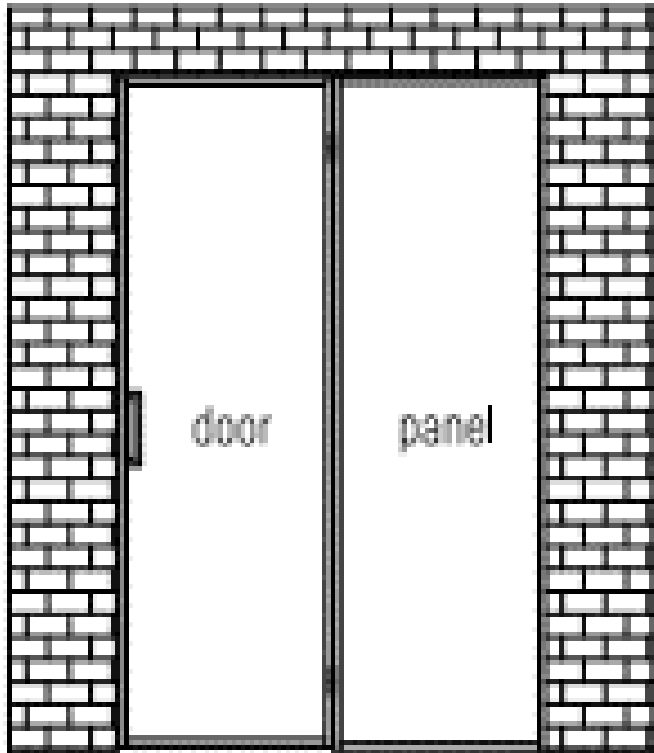

Width up to	Price up to 84" Height	Maximum up to 98" Height
42"	\$3,275	\$3,675
46"	\$3,400	\$3,800
50"	\$3,500	\$3,950
54"	\$3,625	\$4,100
58"	\$3,750	\$4,250
62"	\$3,875	\$4,400
66"	\$4,000	\$4,525
70"	\$4,100	\$4,675
74"	\$4,225	\$4,800
79"	\$4,350	\$4,975

Ideas

- trim is additional and handle costs vary

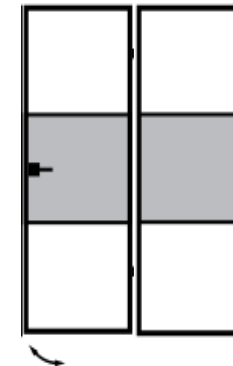

- Fee for delivery and installation in the GTA: **\$387**

LUMI HEAVY - Privacy Enhanced single swing door with one fixed panel and fixed transom above

24

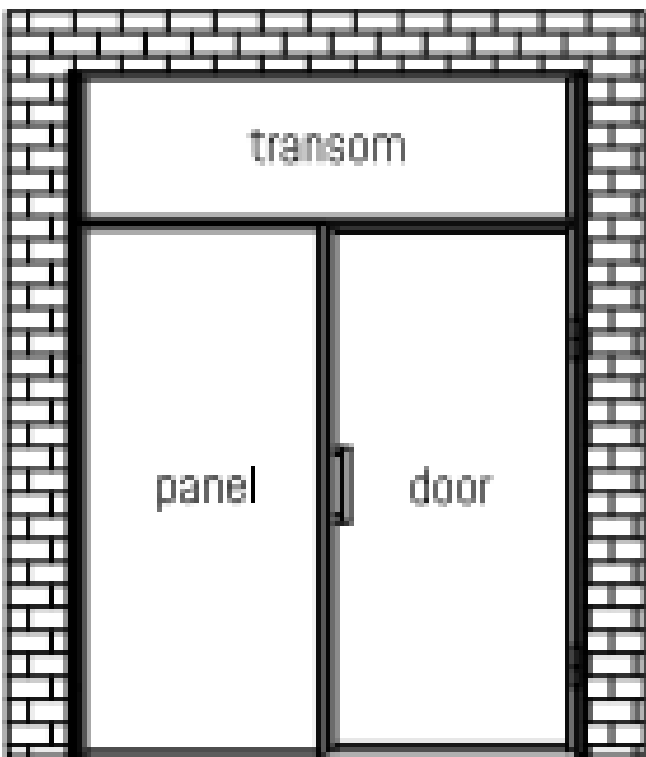

Width up to	Price up to 96" Height	Maximum up to 118" Height
42"	\$3,600	\$4,225
46"	\$3,750	\$4,400
50"	\$3,900	\$4,575
54"	\$4,050	\$4,750
58"	\$4,200	\$4,925
62"	\$4,350	\$5,100
66"	\$4,500	\$5,250
70"	\$4,625	\$5,425
74"	\$4,775	\$5,600
79"	\$4,950	\$5,800

Ideas

- trim is additional and handle costs vary

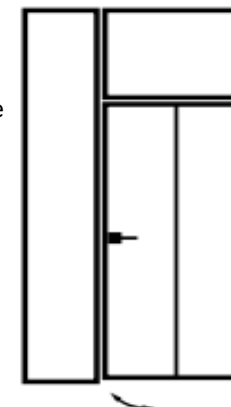

- Door and transom height proportion per customer specification
- Fee for delivery and installation in the GTA: **\$363**

LUMI HEAVY - Privacy Enhanced double swing doors

25

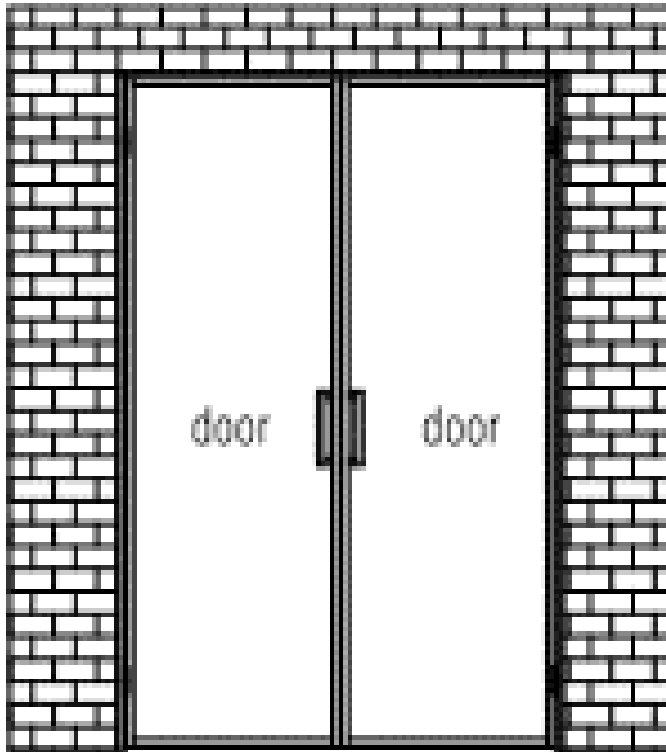

Width up to	Price up to 84" Height	Maximum up to 98" Height
42"	\$3,350	\$3,825
46"	\$3,475	\$3,975
50"	\$3,600	\$4,125
54"	\$3,750	\$4,275
58"	\$3,875	\$4,425
62"	\$4,000	\$4,575
66"	\$4,125	\$4,725
70"	\$4,275	\$4,875
74"	\$4,400	\$5,025
79"	\$4,600	\$5,250

Ideas

- trim is additional and handle costs vary

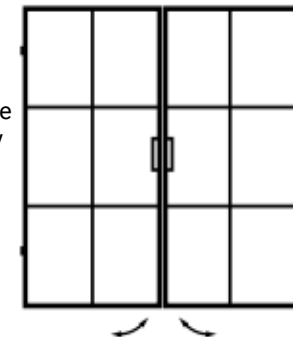

- Fee for delivery and installation in the GTA: **\$296**

LUMI HEAVY - Privacy Enhanced double swing doors with fixed transom above

26

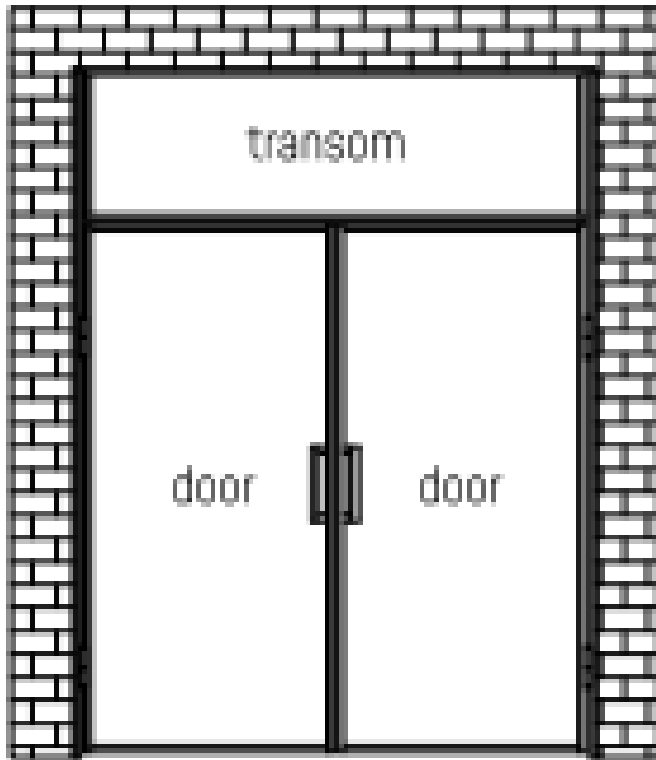

Width up to	Price up to 96" Height	Maximum up to 118" Height
42"	\$3,725	\$4,275
46"	\$3,850	\$4,425
50"	\$4,000	\$4,600
54"	\$4,125	\$4,775
58"	\$4,275	\$4,925
62"	\$4,400	\$5,100
66"	\$4,525	\$5,250
70"	\$4,675	\$5,425
74"	\$4,850	\$5,625
79"	\$5,125	\$5,975

Ideas

- o trim is additional and handle costs vary



- Door and transom height proportion per customer specification
- Fee for delivery and installation in the GTA: **\$387**

LUMI HEAVY - Privacy Enhanced single swing door with two fixed panels

27

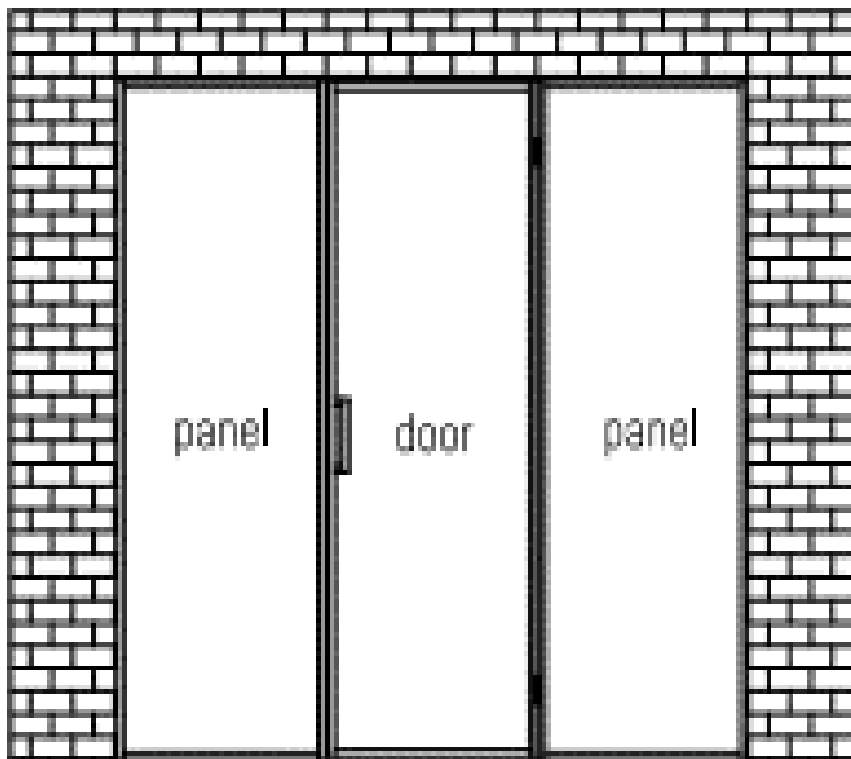

Width up to	Price up to 84" Height	Maximum up to 98" Height
50"	\$4,050	\$4,625
56"	\$4,275	\$4,900
64"	\$4,525	\$5,175
72"	\$4,775	\$5,450
80"	\$5,000	\$5,725
88"	\$5,225	\$6,000
96"	\$5,475	\$6,250
104"	\$5,700	\$6,525
112"	\$5,900	\$6,775
118"	\$6,125	\$7,025

Ideas

- trim is additional and handle costs vary

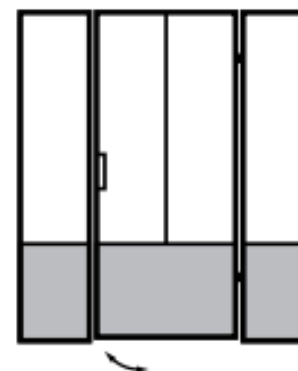

- Fee for delivery and installation in the GTA: **\$523**

LUMI HEAVY- Privacy Enhanced single swing door with fixed transom above and two fixed panels

28

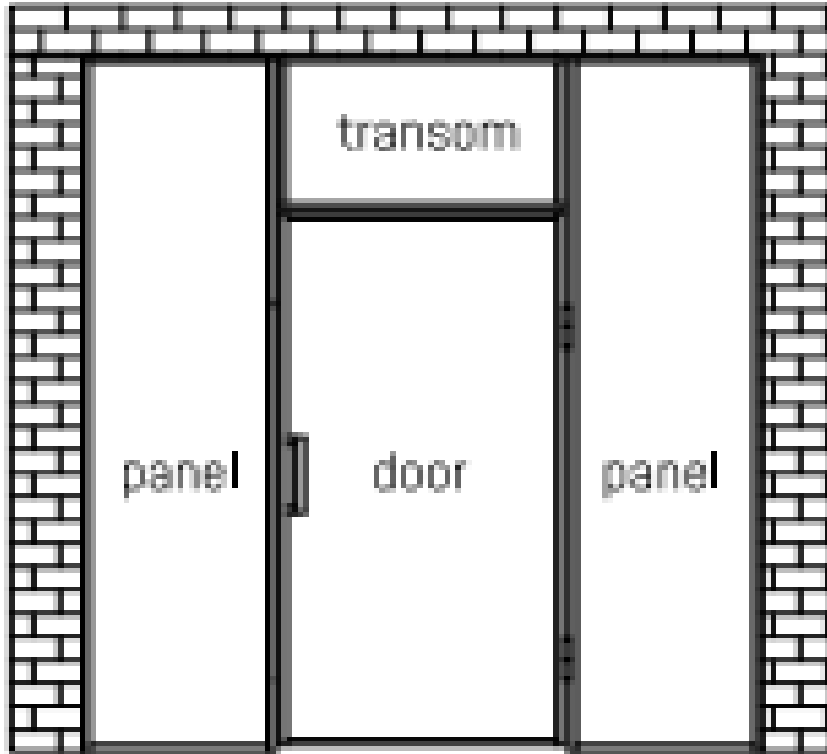

Width up to	Price up to 96" Height	Maximum up to 118" Height
46"	\$4,425	n/a
54"	\$4,700	n/a
62"	\$4,975	n/a
70"	\$5,200	n/a
78"	\$5,475	n/a
86"	\$5,775	\$6,900
94"	\$6,025	\$7,250
102"	\$6,300	\$7,575
110"	\$6,550	\$7,900
118"	\$6,850	\$8,250

Ideas

- trim is additional and handle costs vary

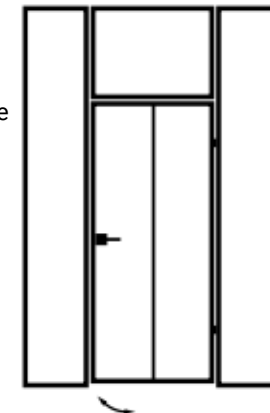

- Door and transom height proportion per customer specification
- Fee for delivery and installation in the GTA: **\$615**

LUMI HEAVY - Privacy Enhanced double swing doors with one fixed panel

29

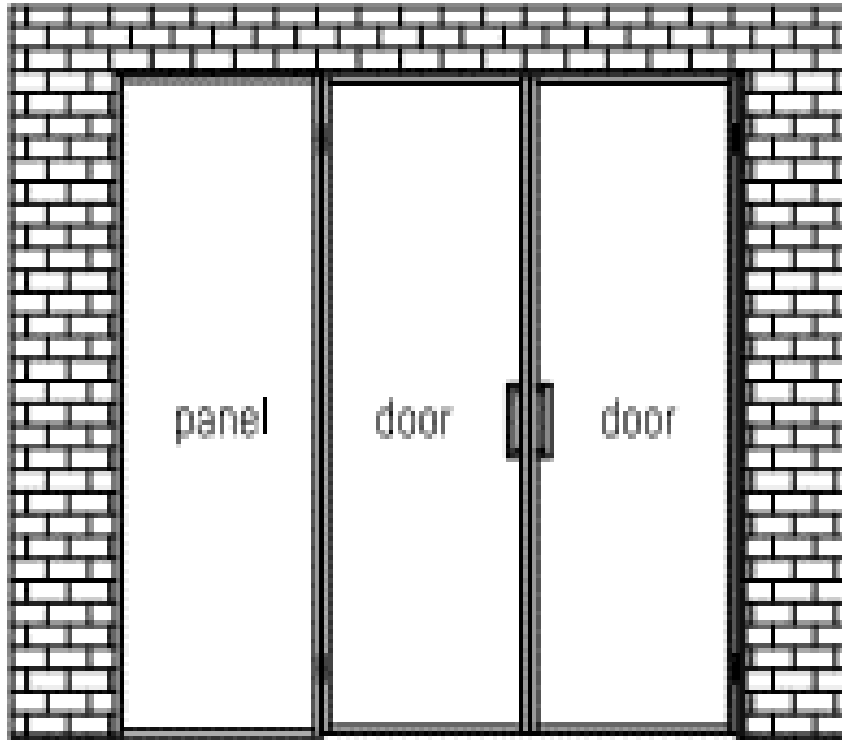

Width up to	Price up to 84" Height	Maximum up to 98" Height
48"	n/a	n/a
54"	\$4,225	\$4,825
62"	\$4,450	\$5,125
70"	\$4,700	\$5,400
78"	\$4,925	\$5,675
86"	\$5,150	\$5,975
94"	\$5,400	\$6,250
102"	\$5,600	\$6,500
110"	\$5,825	\$6,775
118"	\$6,175	\$7,200

Ideas

- trim is additional and handle costs vary

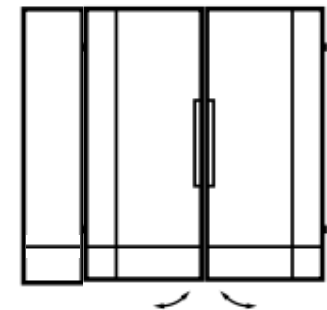

- Fee for delivery and installation in the GTA: **\$432**

LUMI HEAVY - Privacy Enhanced double swing doors with two fixed panels

30

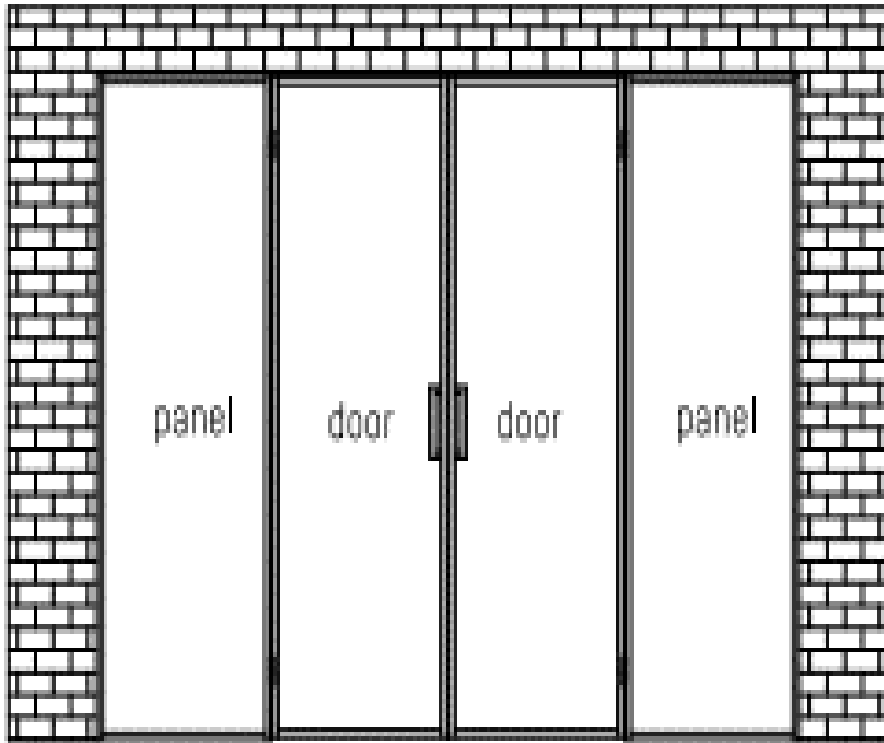

Width up to	Price up to 84" Height	Maximum up to 98" Height
60"	\$4,900	\$5,600
70"	\$5,175	\$5,925
80"	\$5,475	\$6,250
90"	\$5,750	\$6,575
100"	\$6,025	\$6,900
110"	\$6,300	\$7,200
120"	\$6,575	\$7,525
130"	\$6,825	\$7,825
140"	\$7,150	\$8,200
158"	\$8,025	\$9,200

Ideas

- trim is additional and handle costs vary

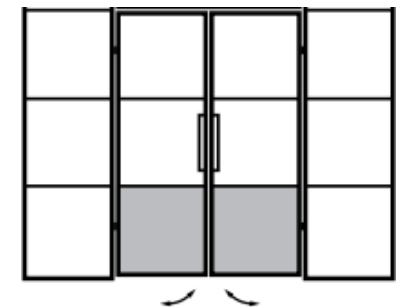

- Fee for delivery and installation in the GTA: **\$567**

LUMI HEAVY - Privacy Enhanced double swing doors with fixed transom above and two fixed panels

31

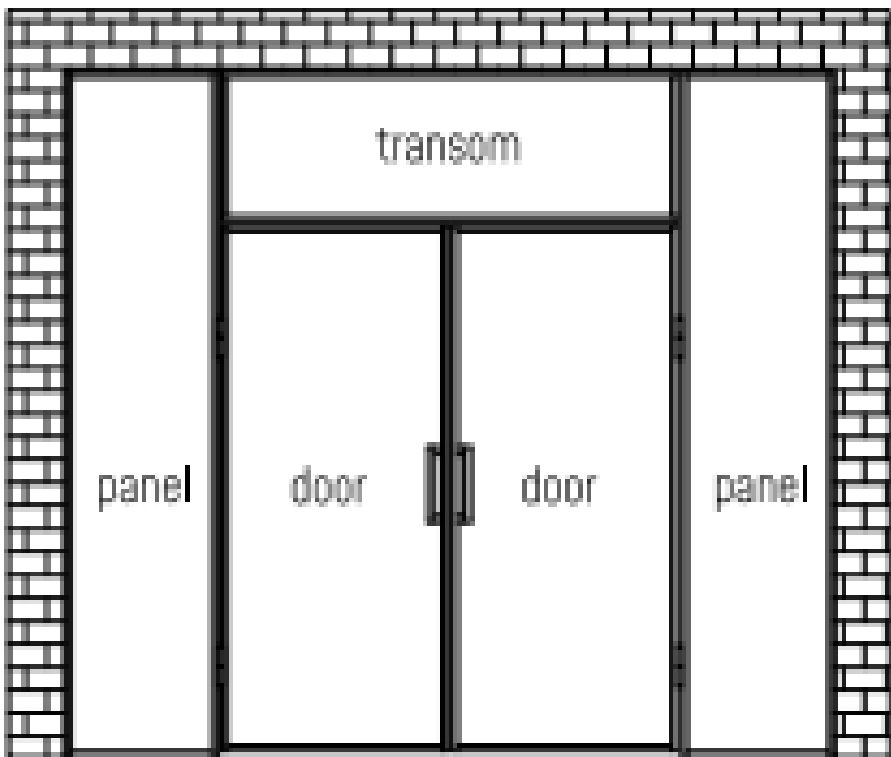

Width up to	Price up to 96" Height	Maximum up to 118" Height
60"	\$5,825	n/a
70"	\$6,150	n/a
80"	\$6,475	\$8,075
90"	\$6,825	\$8,450
100"	\$7,200	\$8,800
110"	\$7,525	\$9,125
120"	\$7,850	\$9,425
130"	\$8,150	\$9,700
140"	\$8,525	\$10,075
158"	\$9,475	\$11,200

Ideas

- trim is additional and handle costs vary

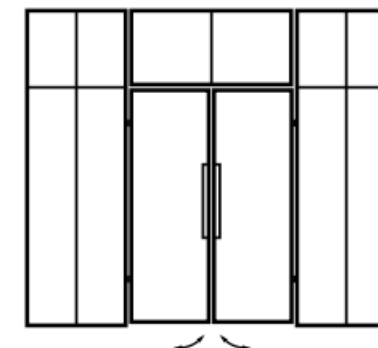

- Door and transom height proportion per customer specification
- Fee for delivery and installation in the GTA: **\$750**

LUMI

ADJUSTABLE



LUMI ADJUSTABLE - Single swing door in a rough opening

Single Swing with Adjustable Casing

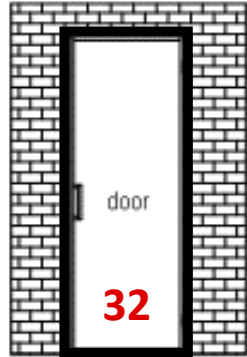

Fits into rough openings where the walls are finished but the door jam has not been closed off and finished.

Priced at standard 4" wall width, but can be fitted to up to an 7"+ wall width

Particularly effective solution when bridging two differing walls widths

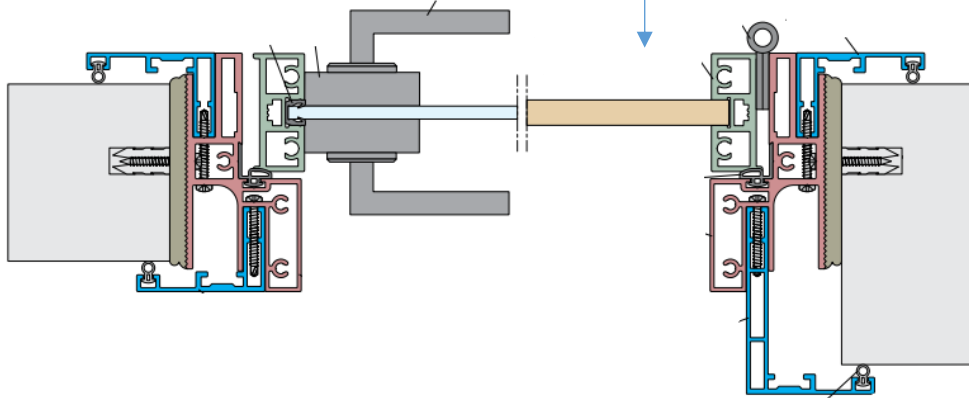

ADJUSTABLE DOOR FRAME - RANGES

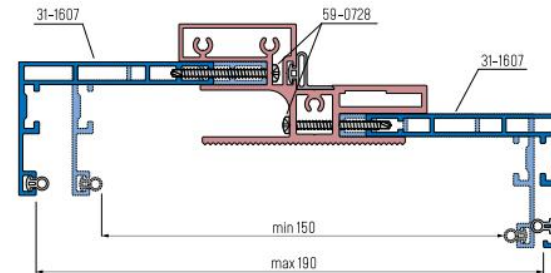
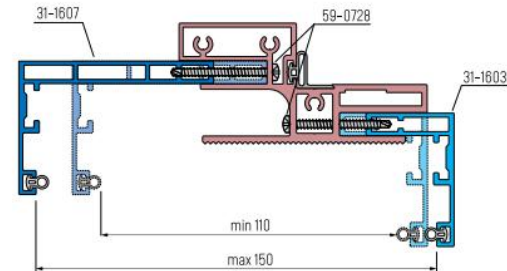
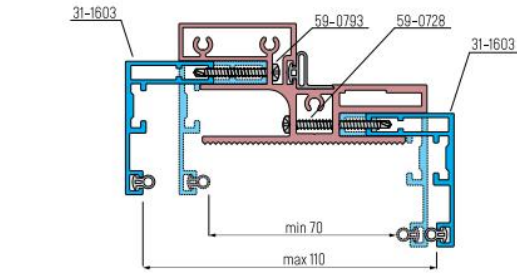

Glazed interior doors in an aluminium frame. A single, hinged leaf in a frame, with a grip or door handle. The variety of divisions and fillings allows the door to be adapted to all requirements, giving the interior a loft look.



KOMANDOR

LUMI ADJUSTABLE - Single swing door in a rough opening

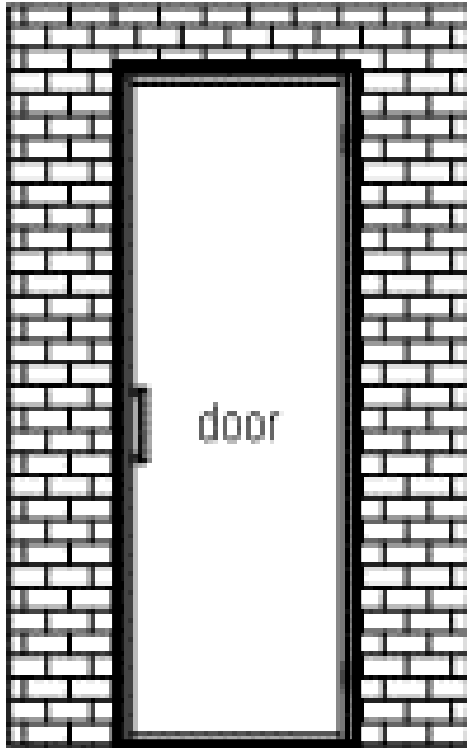

32

	Mininum of 69" Height	Price up to 86" Height	Maximum up to 100" Height
Width			
26.6"	\$2,525	\$2,850	\$3,325
28"	\$2,550	\$2,900	\$3,375
30"	\$2,625	\$2,975	\$3,475
32"	\$2,700	\$3,050	\$3,550
34"	\$2,750	\$3,125	\$3,625
36"	\$2,825	\$3,200	\$3,725
38"	\$2,875	\$3,275	\$3,825
40"	\$2,950	\$3,350	\$3,875
42.3"	\$3,025	\$3,425	\$3,975

➤ Heights and widths listed include the variable ~2" adjustable frame, please subtract ~2" from height & ~4" from width for actual door size

Ideas

- trim is additional and handle costs vary

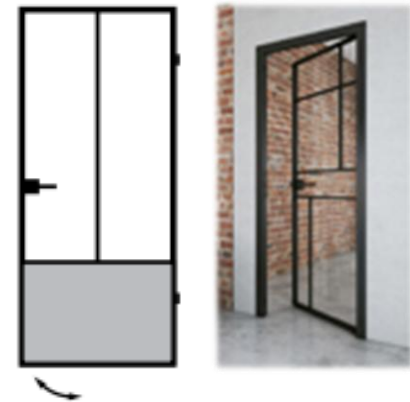

- Fee for delivery and installation in the GTA: **\$325**

RECENT PROJECTS – IDEAS BROUGHT TO LIFE

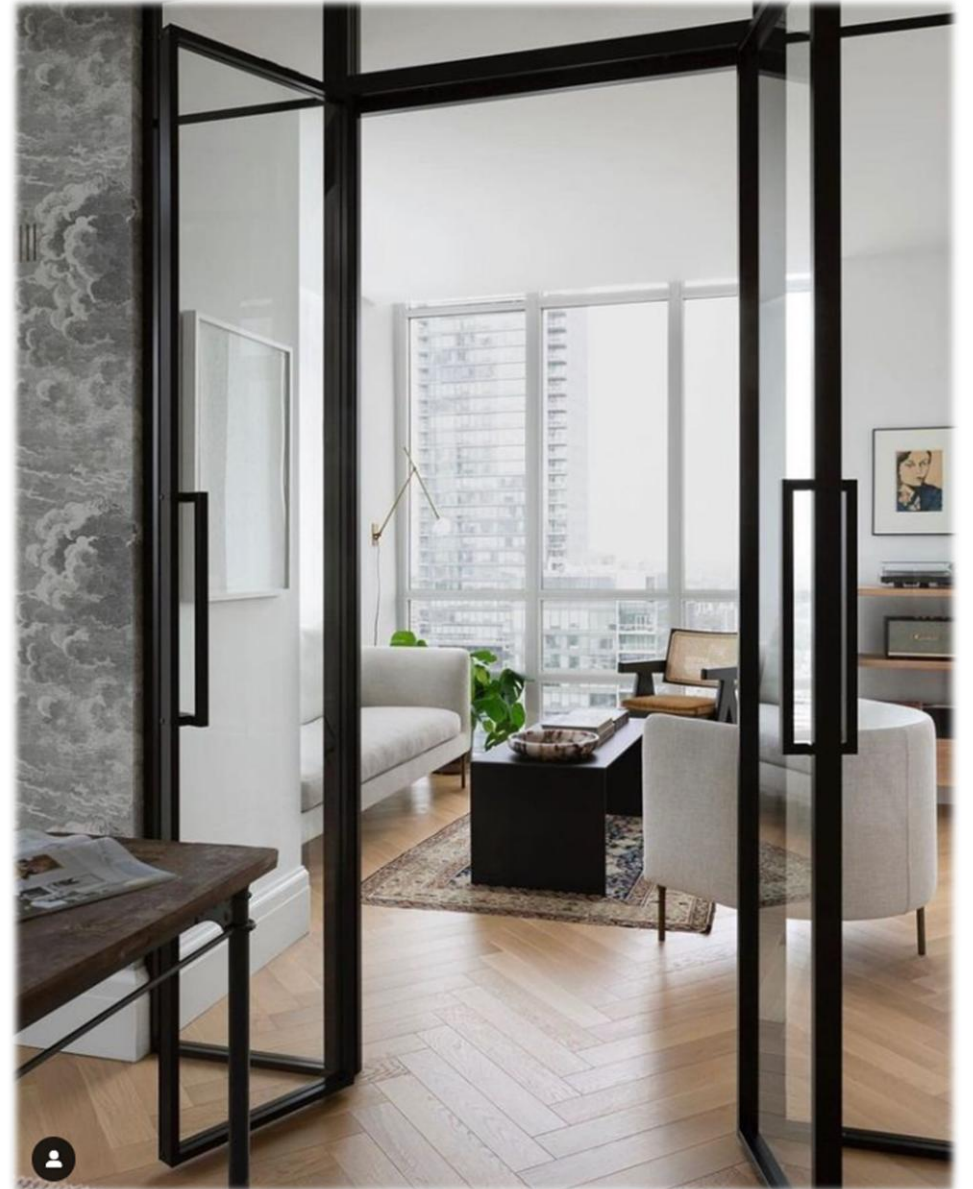

LUMI - OPTIONS

FRAME FINISH

Black matte

- as priced in this guide

Percentages to be calculated on **original unmodified base price** as listed in this Price Guide

Anode natural

- less 7% to 10% of black matte, depending on ratio of glass inserts to frame. The smaller the glass the larger the discount

Custom powder coating

- hundreds of colours and many textures, please connect with us for a quote



LUMI - OPTIONS

INSERTS

Clear laminated safety glass

- as priced in this guide

Percentages to be calculated on **original unmodified base price** as listed in this Price Guide

Clear tempered glass

- add 3% to 5% of total price, increasing with width and height of glass

Frosted effect laminated safety glass

- add 3% to 5% of total price, increasing with width and height of glass

Architectural glass

- add 4% to 8% of total price, increasing with width and height of glass
- Textured, tinted, ultra clear: dozens of styles to choose from
- Some of our most popular include reeded, cross-reeeded, and fluted sandblasted

Melamine panel

- less 20% to 30% of total price, increasing with width and height of insert: this assumes total replacement of glass in entirety of project
- should only a portion of project be replaced with an alternative insert, please calculate percentage of total project to which this surcharge or reduction applies
- should a single panel/door contain multiple inserts, please factor in the cost of trim piece to join inserts, or connect with us for a quote

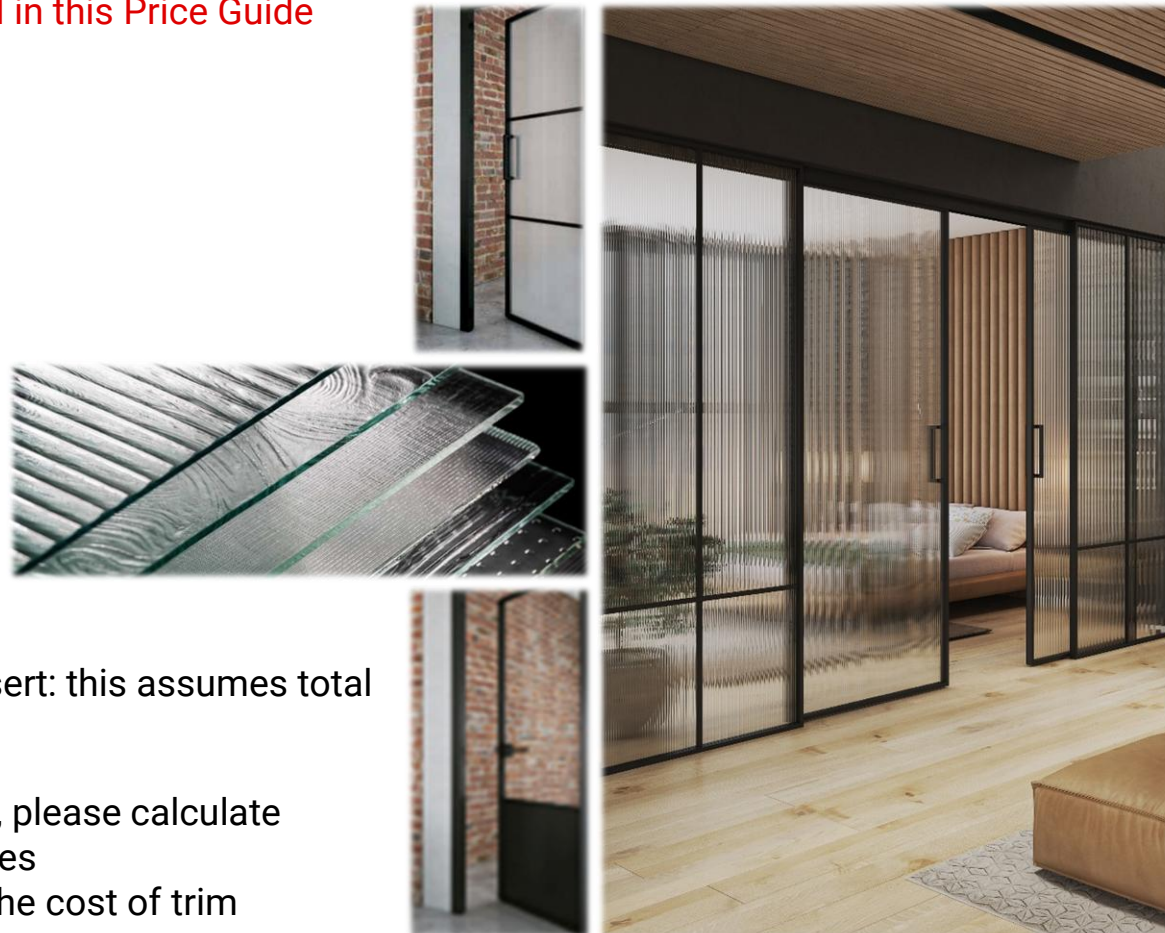

LUMI - OPTIONS

DECORATIVE TRIM

Percentages to be calculated on **original unmodified base price** as listed in this Price Guide

Horizontal

- approx. \$1.50 per inch
- OR *per trim* extending entire width of installation, add 3% of total price

Vertical

- approx. \$1.50 per inch
- OR *per trim* extending entire height of installation, add 6% of total price

Custom angle

- please connect with us for a quote

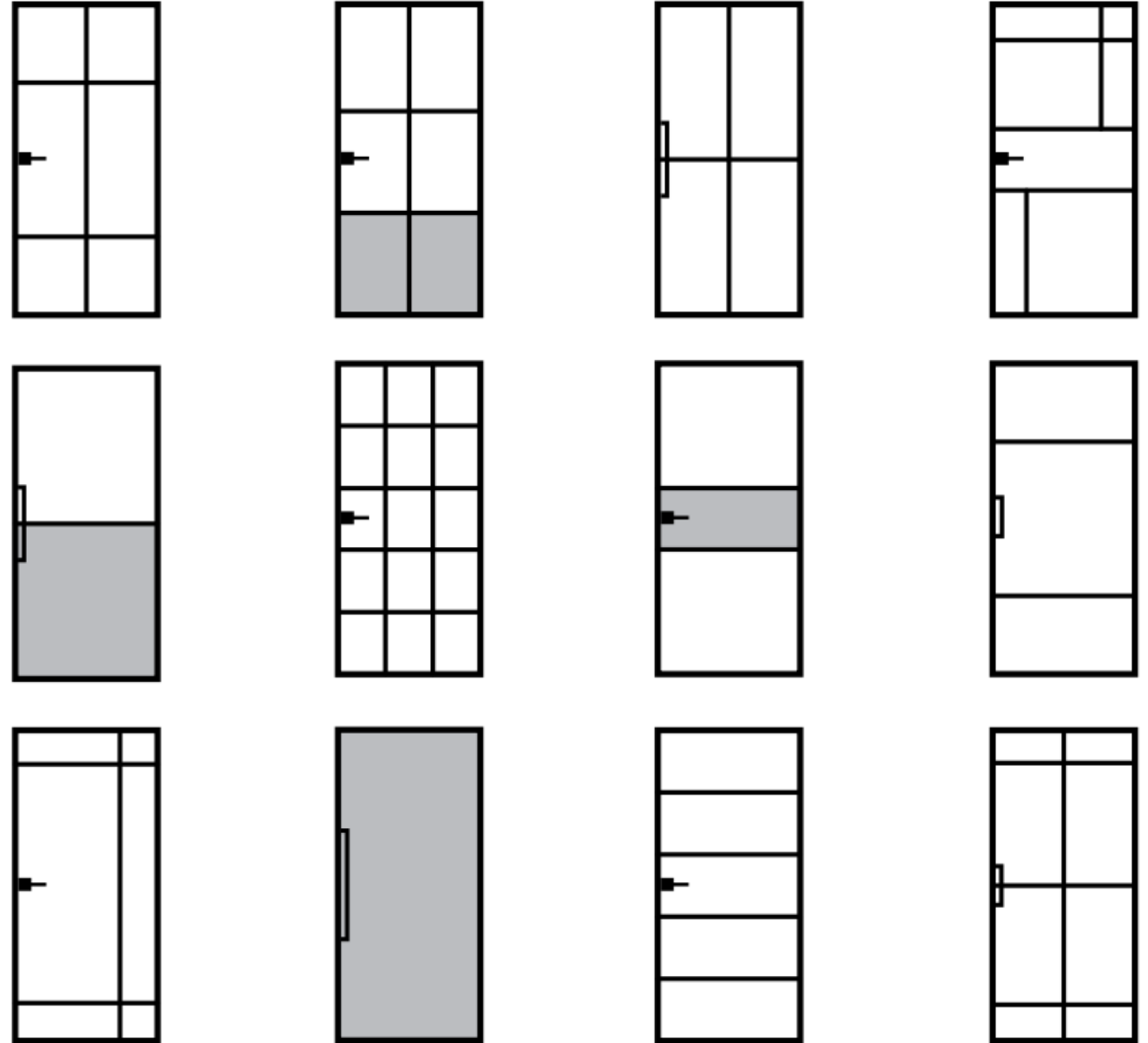

LUMI - OPTIONS

DOOR CLOSURE HARWARE



Soft Close Mechanism for Sliding Doors

\$265 per door

Sliding doors can be fitted with a soft close mechanism which gently capture and ease the door into the closed position.



Self-Closing Hinges for Swing Doors *

\$35-\$70 per door

Swing doors can be fitted with self-closing hinges which gently ease the door into the closed position. The rate of speed for closing swing is adjustable.

* compatible with LUMI Heavy only

LUMI - OPTIONS

HANDLES HARDWARE MOUNTED DIRECTLY TO GLASS DOOR

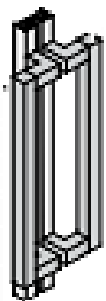

D handle

Small

Medium

Large

6¼" (160mm)

11¼" (288mm)

17½" (448mm)

deduct \$50/door

as priced

additional \$50/door

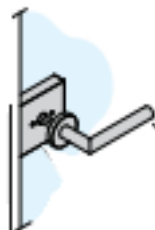
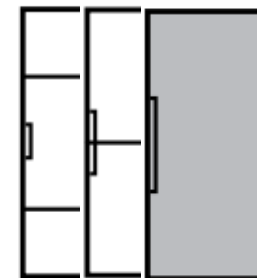

Lever

Plain

With bolt *

With lock *

additional \$150/door

additional \$150/door

additional \$375/door



Opal pull

Small

Medium

Large

4¾" (120mm)

8½" (216mm)

13½" (344mm)

deduct \$120/door

deduct \$110/door

deduct \$90/door

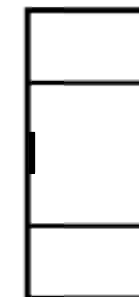

* compatible with LUMI Heavy only

LUMI - OPTIONS

HANDLE HARDWARE MOUNTED TO PLATE ADAPTER OR INFILL PANEL



Plate Adapter *

\$275 plus lockset

Custom plate made to order; size, panel material and finish to client specification. Must have a minimum of 1" from 3 edges of lockset.



Infill Panel

\$325 plus dummy / lockset *

Custom panel made to order (running either horizontally or vertically), size, panel material and finish to client specification. Must have a minimum of 1" from 3 edges of dummy / lockset.

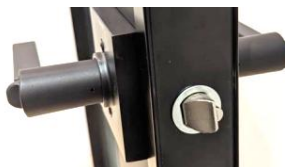

Handle Hardware

\$\$\$ dummy / lockset *

Choose from our selection of handle hardware, or provide your own. Options include dummy, passage *, privacy *, keyed lock one side *, keyed lock two sides *, combination lock *, and smart locks *

- chosen handle hardware **MUST** have round drive in (knock in) bolt trim ring
- rectangular bolt plate cannot be accommodated.

Off the shelf lockset advantages include: easily replaced/updated, keys easily duplicated, many styles and finishes, ability to match handles throughout the space



* compatible with LUMI Heavy only

LUMI - WARRANTY, MAINTENANCE & SERVICE

Warranty

- 10 year warranty on manufacturer's defect and on installation performed by our install teams
- 2 year warranty on parts/manufacturer's defect on all supply-only projects
- We guarantee that your Komandor product will be free of defects which include the operation of all moving parts, painted or coated products and laminated panel or glass products will be free from abnormal discolourations, peeling or any other foreseeable defect for the warranty period.

Maintenance

- Once installed and initially adjusted, doors should not ever need to be re-adjusted
- Top roller guides on sliding doors do not require any oil or grease and typically require no adjustment or servicing in any way
- Hinges for swings doors do not require lubrication at any point
- Frames and tracks occasionally need to be wiped down with a damp cloth for cleaning. A mild solution of soap and water may be used if necessary
- Fine scratches can sometimes be polished out using automotive polish or wax which can be purchased at most hardware stores. Deep chips or scratches that expose raw aluminum cannot be polished out; an automotive grade touch up paint can be used to cover this type of damage.
- To clean glass, spray cleaner onto cloth and then gently wipe down

Service

- free servicing within the warranty period, or connect with us beyond this time for a quote
- **(905)766-0880** **info@komandor.ca**



KOMANDOR

LUMI

LOFT STYLE DOOR AND GLAZING SYSTEM
ILLUMINATES, DIVIDES AND GIVES UNIQUE TWIST

KOMANDOR CANADA CLOSETS & DOORS INC.
863 Rangeview Rd., Mississauga, ON L5E 1H1
tel: 905.766.0880 www.komandor.ca